

APRIL 2025  
PRICELIST - SW 03



Mfg. by : **FYBROS MODDULAR PVT. LTD.**  
Bldg. No.8, Rajprabha Land Mark Industrial Estate,  
Sativali Road, Gokhivare, Vasai (E), Palghar, Maharashtra - 401208.  
For enq./complaints Contact to above address  
Email: [customercare@fybros.com](mailto:customercare@fybros.com) / Website: [www.fybros.com](http://www.fybros.com)  
Customer Care: 1800-270-6334 / WhatsApp: 707-070-6737



SCAN THE QR CODE  
TO VISIT FYBROS WEBSITE



# Redefining Luxury

# Dare To Dream With Me

Founded in 1968, FYBROS manufactures electrical products of unparalleled quality. Through these decades, we have refined our design process to design products of superior quality that have enabled our customers to create their dream homes. We have developed innovative products that are uniquely distinct, which have set the highest standards in product development in the industry, leading to unprecedented success. Present in a variety of sectors, we continuously develop products to meet market and customers ever evolving needs. With an astute understanding of your specific lifestyle desires, FYBROS products are easy to install, fit for its preferred purposes and designed for every decor. Ultimately, the products we make are elegant, dynamic, and infused with a passion to make your dreams come true.

FYBROS Moddular Pvt. Ltd.  
(Brand Ambassador)

Shruti Haasan

A large, stylized handwritten signature in black ink, appearing to read 'Shruti', is positioned over the bottom right of the text area and extends towards the right edge of the page.

# TOGETHER



**FOUR-X**  
MODULAR SERIES

Series 3 Pure White Plate With Gate Switches in Pure White

Series 5 Snow White Plate With Glide Switches in Pure White

## FOUR-X

SWITCHES	01-03
ACCESSORIES	04-08
F-TOUCH SWITCH	09-11
PLATES	12-17
SURFACE GANG BOX / METAL GANG BOX	18-19
COLOUR	20-22

## WOOD~em

SWITCHES	25-31
ACCESSORIES	32-35
PLATES	36-42
SURFACE GANG BOX / METAL GANG BOX	43-45
COLOUR	46-48

## ZINE

SWITCH & ACCESSORIES	51-53
----------------------	-------

## ZINE PLUS

ACCESSORIES / TRAVEL ADAPTOR	55-56
BELL	57
NIGHT LAMP / FLEX BOX	58
SPIKE GUARD / POWER STRIP	59
HOLDER / CUBE WOOD PLATE	60-62

## ZUNIX

SWITCH & ACCESSORIES	65-68
----------------------	-------

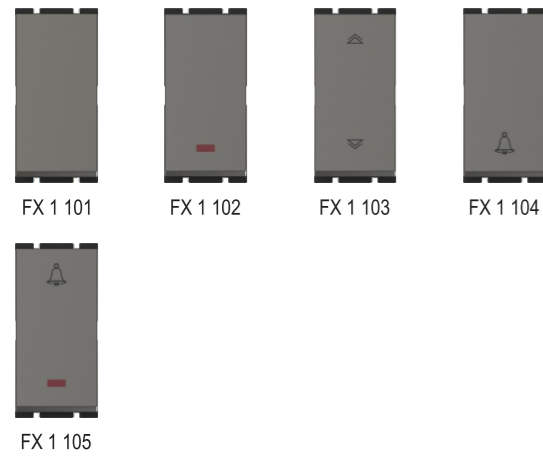

CODE	ITEM	MRP(Rs.)	PURE WHITE	METALLIC CHROME/BLACK	PKG OUTER / MASTER
<b>FOUR-X GRACE 10AX SWITCHES 240V~</b>					
FX 1 101	1 Way Switch	65.00	74.00	20 / 1000	
FX 1 102	1 Way Switch with Indicator (LED)	134.00	149.00	20 / 1000	
FX 1 103	2 Way Switch	134.00	149.00	20 / 1000	
FX 1 104	Bell Push Switch	146.00	163.00	20 / 1000	
FX 1 105	Bell Push Switch with Indicator (LED)	164.00	184.00	20 / 1000	

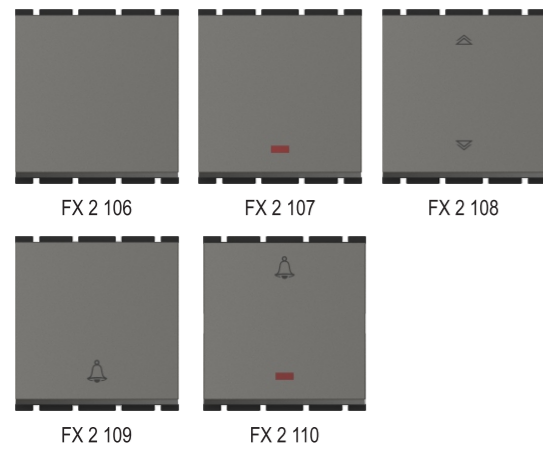

CODE	ITEM	MRP(Rs.)	PURE WHITE	METALLIC CHROME/BLACK	PKG OUTER / MASTER
<b>FOUR-X GRACE 10AX SWITCHES 240V~</b>					
FX 2 106	1 Way Switch	146.00	164.00	10 / 500	
FX 2 107	1 Way Switch with Indicator (LED)	177.00	201.00	10 / 500	
FX 2 108	2 Way Switch	177.00	201.00	10 / 500	
FX 2 109	Bell Push Switch	186.00	209.00	10 / 500	
FX 2 110	Bell Push Switch with Indicator (LED)	193.00	218.00	10 / 500	

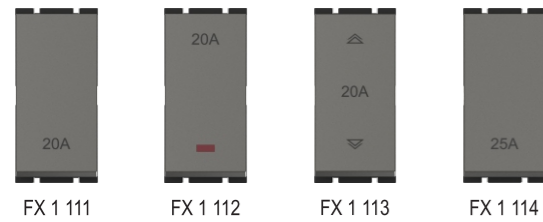

CODE	ITEM	MRP(Rs.)	PURE WHITE	METALLIC CHROME/BLACK	PKG OUTER / MASTER
<b>FOUR-X GRACE 20AMP / 25AMP SWITCHES 240V~</b>					
FX 1 111	20A 1 Way Switch	163.00	172.00	20 / 1000	
FX 1 112	20A 1 Way Switch with Indicator (LED)	209.00	227.00	20 / 1000	
FX 1 113	20A 2 Way Switch	207.00	233.00	20 / 1000	
FX 1 114	25A 1 Way Switch	227.00	255.00	20 / 1000	

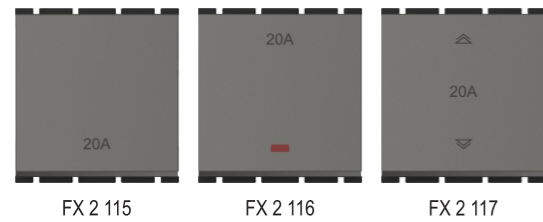

CODE	ITEM	MRP(Rs.)	PURE WHITE	METALLIC CHROME/BLACK	PKG OUTER / MASTER
<b>FOUR-X GRACE 20AMP SWITCHES 240V~</b>					
FX 2 115	20A 1 Way Switch	192.00	216.00	10 / 500	
FX 2 116	20A 1 Way Switch with Indicator (LED)	217.00	246.00	10 / 500	
FX 2 117	20A 2 Way Switch	229.00	258.00	10 / 500	

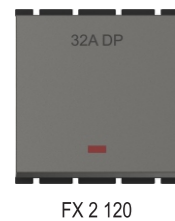

CODE	ITEM	MRP(Rs.)	PURE WHITE	METALLIC CHROME/BLACK	PKG OUTER / MASTER
<b>FOUR-X GRACE 32AMP DP SWITCH 240V~</b>					
FX 2 120	32A DP Switch with Indicator (LED)	361.00	405.00	10 / 500	

CODE	ITEM	MRP(Rs.)	PURE WHITE	METALLIC CHROME/BLACK	PKG OUTER / MASTER
<b>FOUR-X GLIDE 10AX SWITCHES 240V~</b>					
FX 1 401	1 Way Switch	69.00	79.00	20 / 1000	
FX 1 402	1 Way Switch with Indicator (LED)	143.00	159.00	20 / 1000	
FX 1 403	2 Way Switch	143.00	159.00	20 / 1000	
FX 1 404	Bell Push Switch	162.00	177.00	20 / 1000	
FX 1 405	Bell Push Switch with Indicator (LED)	181.00	200.00	20 / 1000	

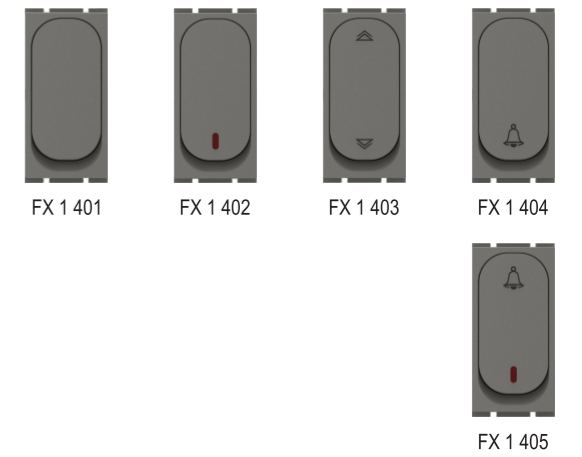

CODE	ITEM	MRP(Rs.)	PURE WHITE	METALLIC CHROME/BLACK	PKG OUTER / MASTER
<b>FOUR-X GLIDE 10AX SWITCHES 240V~</b>					
FX 2 406	1 Way Switch	162.00	181.00	10 / 500	
FX 2 407	1 Way Switch with Indicator (LED)	201.00	223.00	10 / 500	
FX 2 408	2 Way Switch	201.00	223.00	10 / 500	
FX 2 409	Bell Push Switch	209.00	232.00	10 / 500	
FX 2 410	Bell Push Switch with Indicator (LED)	219.00	245.00	10 / 500	

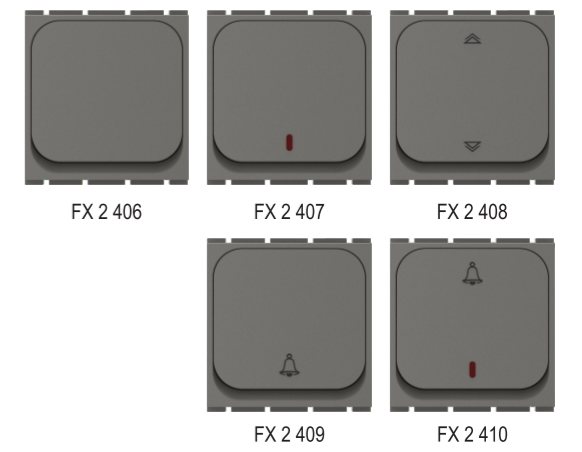

CODE	ITEM	MRP(Rs.)	PURE WHITE	METALLIC CHROME/BLACK	PKG OUTER / MASTER
<b>FOUR-X GLIDE 20AMP / 25AMP SWITCHES 240V~</b>					
FX 1 411	20A 1 Way Switch	171.00	181.00	20 / 1000	
FX 1 412	20A 1 Way Switch with Indicator (LED)	222.00	237.00	20 / 1000	
FX 1 413	20A 2 Way Switch	219.00	246.00	20 / 1000	
FX 1 414	25A 1 Way Switch	239.00	268.00	20 / 1000	

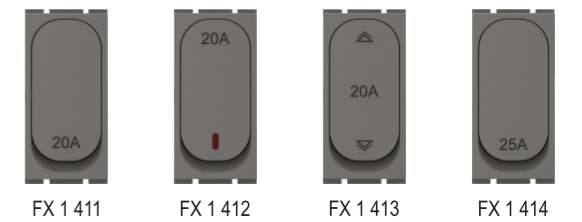

CODE	ITEM	MRP(Rs.)	PURE WHITE	METALLIC CHROME/BLACK	PKG OUTER / MASTER
<b>FOUR-X GLIDE 20AMP SWITCHES 240V~</b>					
FX 2 415	20A 1 Way Switch	217.00	242.00	10 / 500	
FX 2 416	20A 1 Way Switch with Indicator (LED)	247.00	276.00	10 / 500	
FX 2 417	20A 2 Way Switch	263.00	292.00	10 / 500	

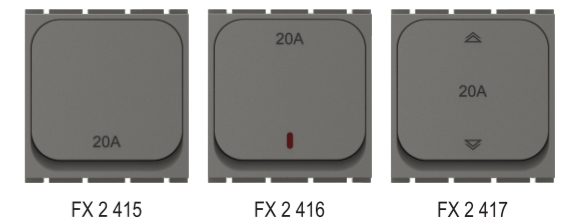

CODE	ITEM	MRP(Rs.)	PURE WHITE	METALLIC CHROME/BLACK	PKG OUTER / MASTER
<b>FOUR-X GLIDE 32AMP DP SWITCH 240V~</b>					
FX 2 420	32A DP Switch with Indicator (LED)	401.00	446.00	10 / 500	



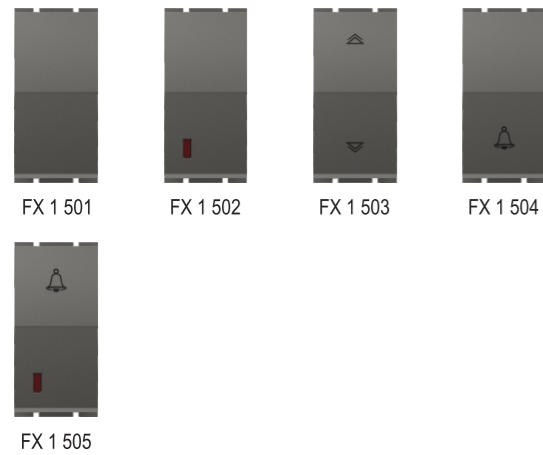

CODE	ITEM	MRP(Rs.)	PURE WHITE	METALLIC CHROME/BLACK	PKG OUTER / MASTER
<b>FOUR-X GLAM 10AX SWITCHES 240V~</b> <span style="float:right">NEW</span>					
FX 1 501	1 Way Switch	65.00	74.00	20 / 1000	
FX 1 502	1 Way Switch with Indicator (LED)	134.00	149.00	20 / 1000	
FX 1 503	2 Way Switch	134.00	149.00	20 / 1000	
FX 1 504	Bell Push Switch	146.00	163.00	20 / 1000	
FX 1 505	Bell Push Switch with Indicator (LED)	164.00	184.00	20 / 1000	

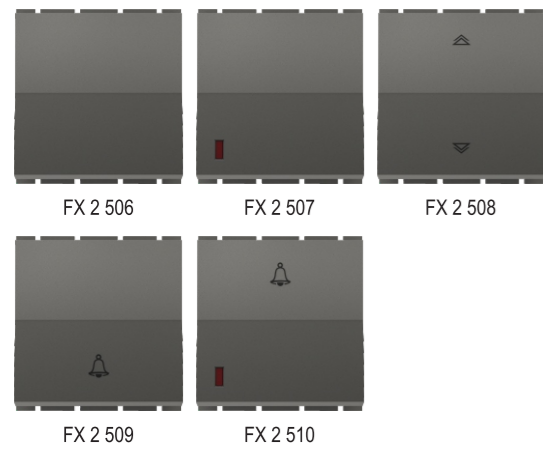

CODE	ITEM	MRP(Rs.)	PURE WHITE	METALLIC CHROME/BLACK	PKG OUTER / MASTER
<b>FOUR-X GLAM 10AX SWITCHES 240V~</b> <span style="float:right">NEW</span>					
FX 2 506	1 Way Switch	146.00	164.00	10 / 500	
FX 2 507	1 Way Switch with Indicator (LED)	177.00	201.00	10 / 500	
FX 2 508	2 Way Switch	177.00	201.00	10 / 500	
FX 2 509	Bell Push Switch	186.00	209.00	10 / 500	
FX 2 510	Bell Push Switch with Indicator (LED)	193.00	218.00	10 / 500	

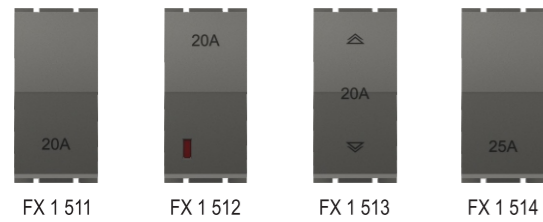

CODE	ITEM	MRP(Rs.)	PURE WHITE	METALLIC CHROME/BLACK	PKG OUTER / MASTER
<b>FOUR-X GLAM 20AMP / 25AMP SWITCHES 240V~</b> <span style="float:right">NEW</span>					
FX 1 511	20A 1 Way Switch	163.00	172.00	20 / 1000	
FX 1 512	20A 1 Way Switch with Indicator (LED)	209.00	227.00	20 / 1000	
FX 1 513	20A 2 Way Switch	207.00	233.00	20 / 1000	
FX 1 514	25A 1 Way Switch	227.00	255.00	20 / 1000	

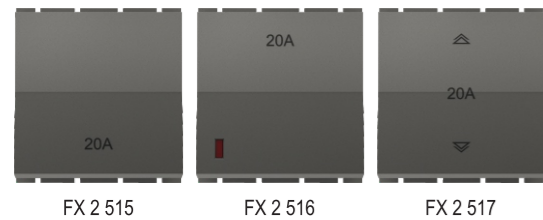

CODE	ITEM	MRP(Rs.)	PURE WHITE	METALLIC CHROME/BLACK	PKG OUTER / MASTER
<b>FOUR-X GLAM 20AMP SWITCHES 240V~</b> <span style="float:right">NEW</span>					
FX 2 515	20A 1 Way Switch	192.00	216.00	10 / 500	
FX 2 516	20A 1 Way Switch with Indicator (LED)	217.00	246.00	10 / 500	
FX 2 517	20A 2 Way Switch	229.00	258.00	10 / 500	

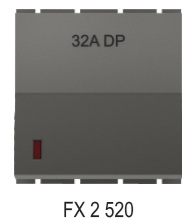

CODE	ITEM	MRP(Rs.)	PURE WHITE	METALLIC CHROME/BLACK	PKG OUTER / MASTER
<b>FOUR-X GLAM 32AMP DP SWITCH 240V~</b> <span style="float:right">NEW</span>					
FX 2 520	32A DP Switch with Indicator (LED)	361.00	405.00	10 / 500	

NEWLY INTRODUCED

CODE	ITEM	MRP(Rs.)	PURE WHITE	METALLIC CHROME/BLACK	PKG OUTER / MASTER
<b>FOUR-X 6AMP / 13AMP SOCKETS 240V~</b>					
FX 1 121	6A 2 Pin Socket with safety shutter	118.00	134.00	20 / 1000	
FX 2 122	6A 2x1 Socket with safety shutter	143.00	162.00	10 / 500	
FX 2 123	6A 2x1 Socket without safety shutter	131.00	151.00	10 / 500	
FX 2 124	6A 3 Pin Socket with safety shutter	139.00	160.00	10 / 500	
FX 2 125	6A 3 Pin Socket without safety shutter	131.00	151.00	10 / 500	
FX 2 126	13A International Socket with safety shutter	233.00	264.00	10 / 500	

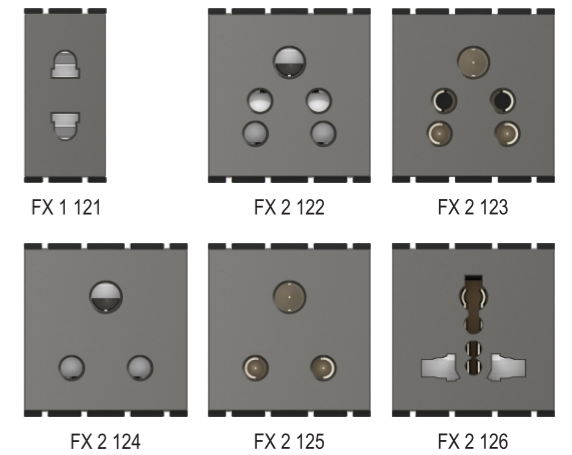

CODE	ITEM	MRP(Rs.)	PURE WHITE	METALLIC CHROME/BLACK	PKG OUTER / MASTER
<b>FOUR-X 6&amp;16AMP UNIVERSAL SOCKETS 240V~</b>					
FX 2 131	6&16A Universal Socket with safety shutter	275.00	294.00	10 / 500	
FX 2 132	6&16A Universal Power Socket with safety shutter	286.00	322.00	10 / 500	
FX 2 133	6&16A Universal Raised Socket with safety shutter	261.00	294.00	10 / 500	
FX 2 134	6&16A Universal Raised Power Socket with safety shutter	286.00	322.00	10 / 500	

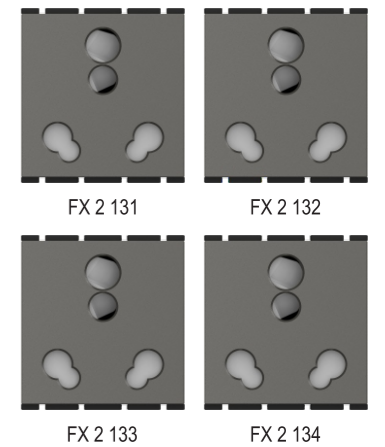

CODE	ITEM	MRP(Rs.)	PURE WHITE	METALLIC CHROME/BLACK	PKG OUTER / MASTER
<b>FOUR-X DIMMER / FAN REGULATOR 240V~</b>					
FX 1 141	ORO Mini Dimmer	328.00	370.00	20 / 600	
FX 1 146	ORO 4 Step Regulator	479.00	518.00	20 / 600	
FX 1 149	ORION 4 Step Regulator	479.00	518.00	20 / 600	

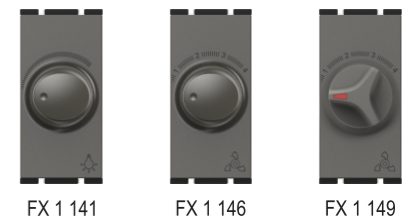

CODE	ITEM	MRP(Rs.)	PURE WHITE	METALLIC CHROME/BLACK	PKG OUTER / MASTER
<b>FOUR-X DIMMER / FAN REGULATOR 240V~</b>					
FX 2 142	ORO Medium Dimmer	397.00	446.00	10 / 300	
FX 2 147	ORO 5 Step Regulator Full Rotary	537.00	581.00	10 / 300	
FX 2 148	OCEAN 5 Step Regulator Half Rotary	537.00	581.00	10 / 300	
FX 2 150	ORION 5 Step Regulator Full Rotary	537.00	581.00	10 / 300	

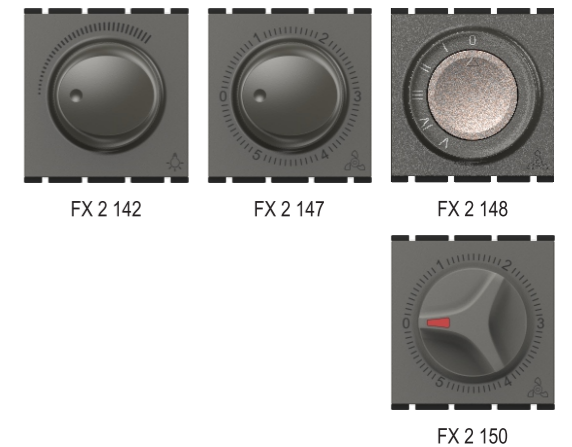

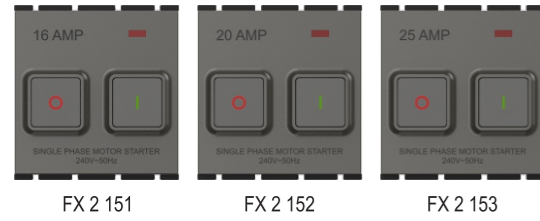

CODE	ITEM	MRP(Rs.)	PURE WHITE	METALLIC CHROME/BLACK	PKG OUTER/MASTER
<b>FOUR-X MOTOR STARTER (SP) 240V~ 50-60Hz</b>					
FX 2 151	16A Motor Starter Switch		660.00	753.00	10 / 300
FX 2 152	20A Motor Starter Switch		660.00	753.00	10 / 300
FX 2 153	25A Motor Starter Switch		660.00	753.00	10 / 300

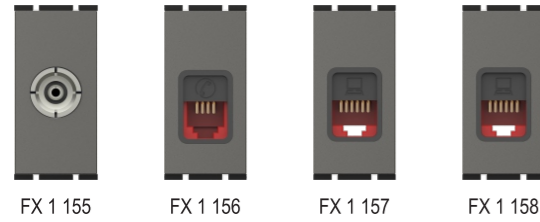

CODE	ITEM	MRP(Rs.)	PURE WHITE	METALLIC CHROME/BLACK	PKG OUTER/MASTER
<b>FOUR-X TV SOCKET / RJ-11 TEL. JACKS / EDP SOCKET</b>					
FX 1 155	TV Socket Coaxial 40-862 Mhz socket		142.00	162.00	20 / 1000
FX 1 156	Telephone Jack - RJ 11		146.00	166.00	20 / 1000
FX 1 157	EDP Socket Outlet - RJ 45 (5e) Universal wiring T568a, Insulating- piercing terminal		313.00	364.00	20 / 1000
FX 1 158	EDP Socket Outlet - RJ 45 (6e) Universal wiring T568a, Insulating- piercing terminal		699.00	750.00	20 / 1000



CODE	ITEM	MRP(Rs.)	PURE WHITE	METALLIC CHROME/BLACK	PKG OUTER/MASTER
<b>FOUR-X TESLA SINGLE POLE MCBs 240V~ 50Hz</b>					
FX 1 161	6A SP MCB		364.00	414.00	20 / 600
FX 1 162	10A SP MCB		364.00	414.00	20 / 600
FX 1 163	16A SP MCB		364.00	414.00	20 / 600
FX 1 164	20A SP MCB		364.00	414.00	20 / 600
FX 1 165	25A SP MCB		364.00	414.00	20 / 600
FX 1 166	32A SP MCB		364.00	414.00	20 / 600
	( Breaking Capacity - 3kA )				

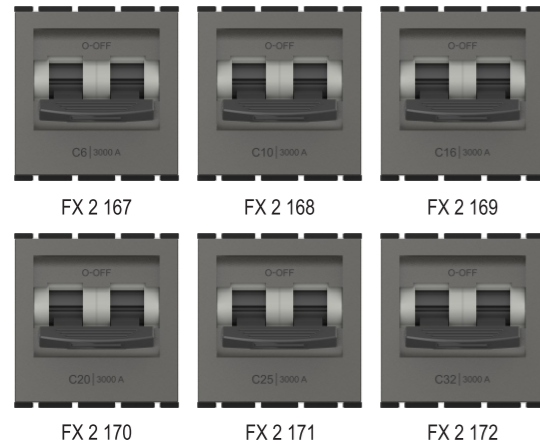

CODE	ITEM	MRP(Rs.)	PURE WHITE	METALLIC CHROME/BLACK	PKG OUTER/MASTER
<b>FOUR-X TESLA DOUBLE POLE MCBs 240V~ 50Hz</b>					
FX 2 167	6A DP MCB		735.00	843.00	10 / 300
FX 2 168	10A DP MCB		735.00	843.00	10 / 300
FX 2 169	16A DP MCB		735.00	843.00	10 / 300
FX 2 170	20A DP MCB		735.00	843.00	10 / 300
FX 2 171	25A DP MCB		735.00	843.00	10 / 300
FX 2 172	32A DP MCB		735.00	843.00	10 / 300
	( Breaking Capacity - 3kA )				

CODE	ITEM	MRP(Rs.)	PURE WHITE	METALLIC CHROME/BLACK	PKG OUTER/MASTER
<b>FOUR-X OVIUS SINGLE POLE MCBs 240V~ 50Hz</b>					
FX 1 261	6A SP MCB		364.00	414.00	20 / 600
FX 1 262	10A SP MCB		364.00	414.00	20 / 600
FX 1 263	16A SP MCB		364.00	414.00	20 / 600
FX 1 264	20A SP MCB		364.00	414.00	20 / 600
FX 1 265	25A SP MCB		364.00	414.00	20 / 600
FX 1 266	32A SP MCB		364.00	414.00	20 / 600
	( Breaking Capacity - 3kA )				



CODE	ITEM	MRP(Rs.)	PURE WHITE	METALLIC CHROME/BLACK	PKG OUTER/MASTER
<b>FOUR-X OVIUS DOUBLE POLE MCBs 240V~ 50Hz</b>					
FX 2 267	6A DP MCB		735.00	843.00	10 / 300
FX 2 268	10A DP MCB		735.00	843.00	10 / 300
FX 2 269	16A DP MCB		735.00	843.00	10 / 300
FX 2 270	20A DP MCB		735.00	843.00	10 / 300
FX 2 271	25A DP MCB		735.00	843.00	10 / 300
FX 2 272	32A DP MCB		735.00	843.00	10 / 300
	( Breaking Capacity - 3kA )				

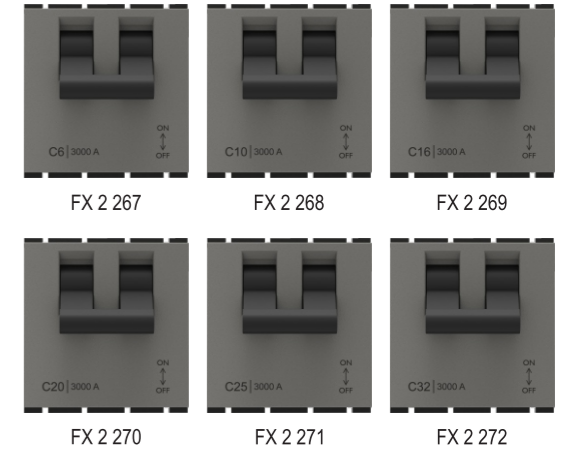

CODE	ITEM	MRP(Rs.)	PURE WHITE	METALLIC CHROME/BLACK	PKG OUTER/MASTER
<b>FOUR-X INDICATOR / BLANK MODULE / FUSE UNIT</b>					
FX 1 176	XION Indicator with Led & Red diffuser		110.00	126.00	20 / 1000
FX 1 177	ORREN Indicator with Led & Red diffuser		110.00	126.00	20 / 1000
FX 1 179	Blank Module		24.00	30.00	50 / 2000
FX 1 180	Kitkat Fuse (10A / 16Amp) with miniature fuse		169.00	193.00	20 / 1000

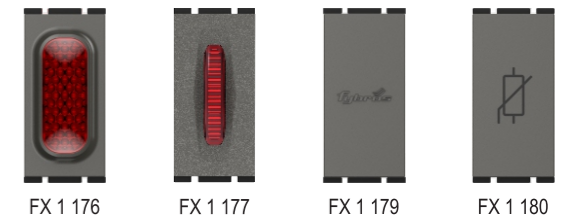

CODE	ITEM	MRP(Rs.)	PURE WHITE	METALLIC CHROME/BLACK	PKG OUTER/MASTER
<b>FOUR-X POP-OUT NIGHT LAMP 240V~ 50-60Hz</b>					
FX 2 183 WH	Night Lamp (LED - White) advance LED light on / off system		673.00	753.00	10 / 240
FX 2 183 WW	Night Lamp (LED - Warm White) advance LED light on / off system		673.00	753.00	10 / 240
FX 2 183 BL	Night Lamp (LED - Blue) advance LED light on / off system		673.00	753.00	10 / 240

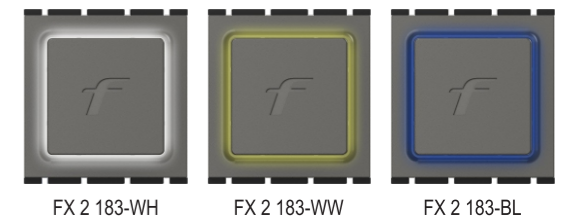

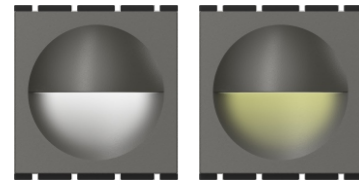

FX 2 184-WH      FX 2 184-WW

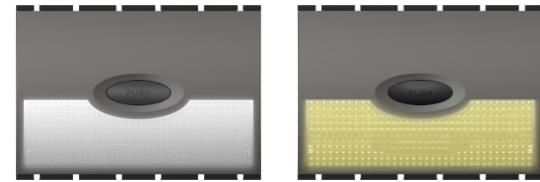

FX 3 185-WH      FX 3 185-WW

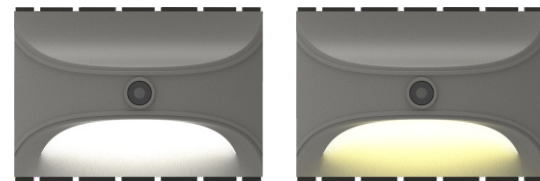

FX 3 186-WH      FX 3 186-WW

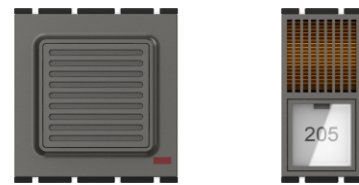

FX 2 197      FX 1 209



FX 2 201      FX 2 202

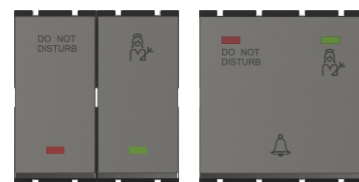

FX 2 206      FX 2 207

● PACKING CHANGE

CODE	ITEM	MRP(Rs.)	PURE WHITE	METALLIC CHROME/BLACK	PKG OUTER / MASTER
<b>FOUR-X STEP MARKER 240V~ 50-60Hz</b>					
FX 2 184 WH	Step Marker (LED - White) with high-efficiency	478.00	559.00	10 / 240	
FX 2 184 WW	Step Marker (LED - Warm White) with high-efficiency	478.00	559.00	10 / 240	
<b>FOUR-X STEP MARKER 240V~ 50-60Hz</b>					
FX 3 185 WH	BRIO Step Marker (LED - White) with high-efficiency	667.00	767.00	10 / 200	
FX 3 185 WW	BRIO Step Marker (LED - Warm White) with high-efficiency	667.00	767.00	10 / 200	
FX 3 186 WH	LUMI Step Marker (LED - White) with high-efficiency & LDR	667.00	767.00	10 / 200	
FX 3 186 WW	LUMI Step Marker (LED - Warm White) with high-efficiency & LDR	667.00	767.00	10 / 200	
<b>FOUR-X ELECTRONIC BUZZER / CALL BELL IND. DISPLAY UNIT 240V~</b>					
FX 2 197	Electronic Buzzer 240V~ 50-60Hz	446.00	481.00	10 / 240	
FX 1 209	Call Bell with Indicator Reset Switch & Name Plate	395.00	443.00	20 / 600	
<b>FOUR-X 32AMP MAIN SWITCH</b>					
FX 2 201	32AMP. DP Main Switch with key tag 240V~, LED Supplied with key tag	551.00	627.00	10 / 500	
FX 2 202	Key Tag Only with Name Plate	128.00	146.00	100 / 2000	
<b>FOUR-X DND / MAKE MY ROOM 240V~</b>					
FX 2 206*	Do Not Disturb / Make My Room 240V~50-60Hz - Inside Room	528.00	601.00	10 / 500	
FX 2 207*	Do Not Disturb / Make My Room 240V~50-60Hz - Outside Room	561.00	642.00	10 / 500	

CODE	ITEM	MRP(Rs.)	PURE WHITE	METALLIC CHROME/BLACK	PKG OUTER / MASTER
<b>FOUR-X USB CHARGER 240V~</b>					
FX 1 215	USB Charger with Usb port & Indicator Input 240V~ 50-60Hz Output-5V DC, 2A	860.00	946.00	20 / 600	
FX 2 216	USB Charger with Usb port & Indicator Input 240V~ 50-60Hz Output-5V DC, 4A	1234.00	1339.00	10 / 300	
FX 1 217	USB Charger with Indicator 1 Port C-Type (Fast Charging) Input 240V~ 50-60Hz Output-20W 3.1A	1208.00	1307.00	20 / 600	
FX 1 218	USB Charger with Indicator 2 Port C-Type & A-Type (Fast Charging) Input 240V~ 50-60Hz Output-18W 3.1A	1440.00	1539.00	20 / 600	
<b>FOUR-X HDMI / AUDIO VIDEO SOCKET 240V~</b>					
FX 1 221	HDMI Socket	1478.00	1596.00	05 / 150	
FX 1 222	Triple RCA Socket (Audio & Video)	1021.00	1091.00	05 / 150	
<b>FOUR-X FOOT LIGHT 240V~ 50-60Hz</b>					
FX 4 226 WH	Foot Light (LED - White) with high-efficiency 2.0W Led	938.00	1014.00	05 / 120	
FX 4 226 WW	Foot Light (LED - Warm White) with high-efficiency 2.0W Led	938.00	1014.00	05 / 120	
<b>FOUR-X MOTION SENSOR / WAVE SWITCH 240V~</b>					
FX 2 231	Motion Sensor Electronic Sensor Switch Supply voltage 180-240V~5A relay output Allows to control lights by simply passing in front of it (Max distance 8mtr.) Upto 5 Switches can be combined to control the same lighting circuit	3459.00	3984.00	05 / 60	
FX 2 233	Wave Switch Electronic Sensor Switch Supply voltage 180-240V~5A relay output Allows to control lights by simply passing the hand in front of it (Max distance 30mm) Upto 5 Switches can be combined to control the same lighting circuit.	3459.00	3984.00	05 / 60	

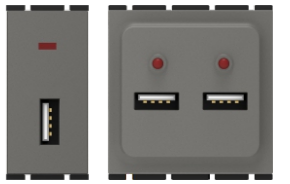

FX 1 215      FX 2 216

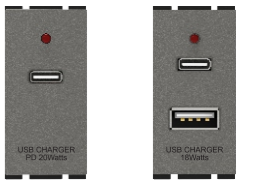

FX 1 217      FX 1 218

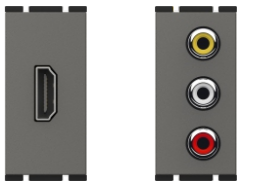

FX 1 221      FX 1 222



FX 4 226-WH

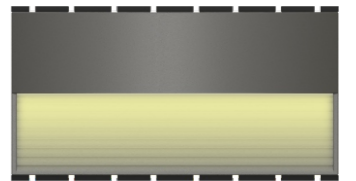

FX 4 226-WW

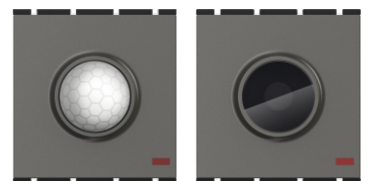

FX 2 231      FX 2 233

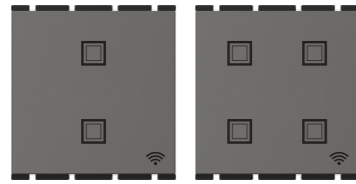

FX 2 601 FX 2 602

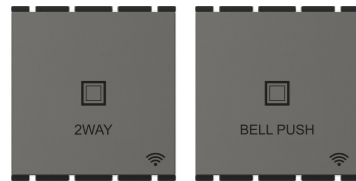

FX 2 603 FX 2 604

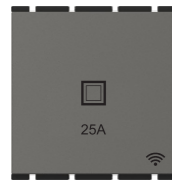

FX 2 605



FX 2 606



FX 2 607

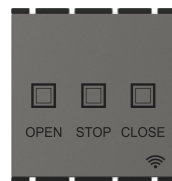

FX 2 608

CODE	ITEM	MRP(Rs.)	METALLIC CHROME	PKG OUTER / MASTER
<b>FOUR-X F-TOUCH SWITCHES / BELL PUSH 120 - 240V~</b> <span style="float:right">NEW</span>				
FX 2 601	2 Switch - 6A each 6A Relay output, CFL - 200W Max. (each switch)	3921.00		05 / 60
FX 2 602	4 Switch - 6A each 6A Relay output, CFL - 200W Max. (each switch)	4497.00		05 / 60
FX 2 603	2 Way Switch 6A Relay output, CFL - 200W Max.	3574.00		05 / 60
FX 2 604	Bell Push Switch 6A Relay output	3921.00		05 / 60
<b>FOUR-X F-TOUCH 25A SWITCH 120 - 240V~</b> <span style="float:right">NEW</span>				
FX 2 605	25A Switch 25A Relay output	3921.00		05 / 60
<b>FOUR-X F-TOUCH LIGHT DIMMER 120 - 240V~</b> <span style="float:right">NEW</span>				
FX 2 606	Light Dimmer Triac Technology with soft end & soft start function operating load -300-450W (Not suitable for FAN)	3921.00		05 / 60
<b>FOUR-X F-TOUCH FAN REGULATOR 120 - 240V~</b> <span style="float:right">NEW</span>				
FX 2 607	5 Step Fan Regulator 6A Relay output with 5 steps fan coil speed operating Load (FAN) - 125W	4497.00		05 / 60
<b>FOUR-X F-TOUCH DRAPE / CURTAIN CONTROLLER 120 - 240V~</b> <span style="float:right">NEW</span>				
FX 2 608	Drape / Curtain controller 6A Relay output	4497.00		05 / 60

**FOUR-X F-TOUCH SWITCH WIRING DIAGRAM**

- 2 Switch**
- Rated Voltage - 120 – 240V~
  - Rated Load - each switch  
Resistive- Up to 800W  
Inductive- Up to 400W  
Capacitive- Up to 18W- 2 lights  
36W- 1 light

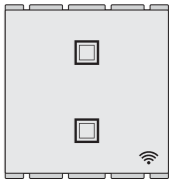
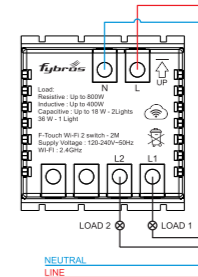

- 4 Switch**
- Rated Voltage - 120 – 240V~
  - Rated Load - each switch  
Resistive- Up to 800W  
Inductive- Up to 400W  
Capacitive- Up to 18W- 2 lights  
36W- 1 light

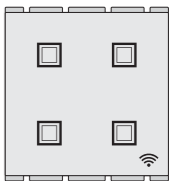
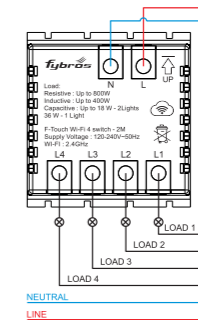

- 2 Way Switch**
- Rated Voltage - 120 – 240V~
  - Rated Load -  
Resistive- Up to 800W  
Inductive- Up to 400W  
Capacitive- Up to 18W- 2 lights  
36W- 1 light

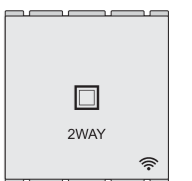
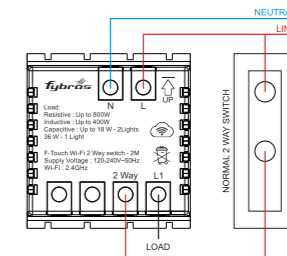

- Bell Push Switch**
- Rated Voltage - 120 – 240V~
  - Rated Load -  
Any DC signal Bell  
AC signal bell up to 800W

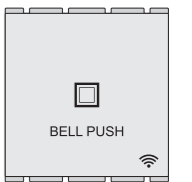
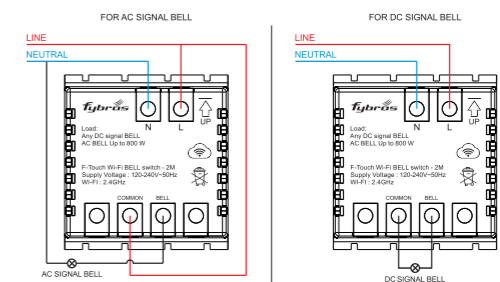

Wire Colour Codes: ■ Red (Live) ■ Blue (Neutral) ■ Black (Load)

**FOUR-X F-TOUCH SWITCH WIRING DIAGRAM**

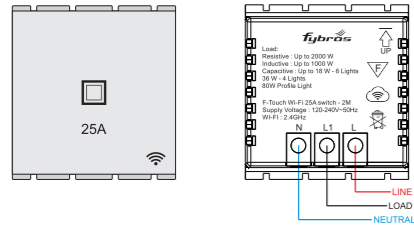

**25A Switch**

- Rated Voltage - 120 – 240V~
- Rated Load -
  - Resistive- Up to 2000W
  - Inductive- Up to 1000W
  - Capacitive- Up to 18W- 6 lights
  - 36W- 4 lights
  - 80W profile light

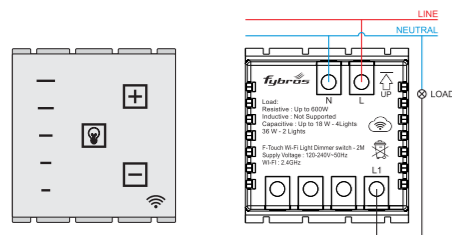

**Light Dimmer**

- Rated Voltage - 120 – 240V~
- Rated Load -
  - Resistive- Up to 600W
  - Inductive- Not supported
  - Capacitive- Up to 18W- 4 lights
  - 36W- 2 lights

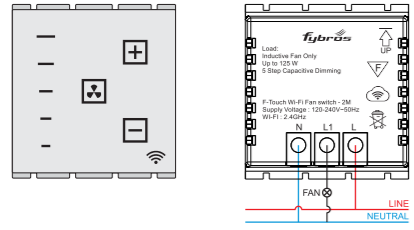

**5 Step Fan Regulator**

- Rated Voltage - 120 – 240V~
- Rated Load -
  - Inductive Fan only- Up to 125W
  - 5 Step capacitive Dimming

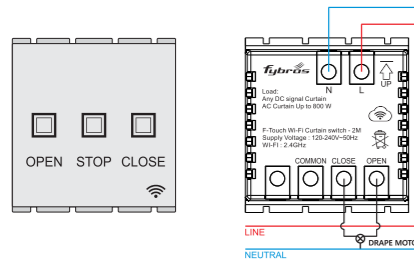

**Drape / Curtain Controller**

- Rated Voltage - 120 – 240V~
- Rated Load -
  - Any DC signal Curtain
  - AC curtain up to 800W

Wire Colour Codes: ■ Red (Live) ■ Blue (Neutral) ■ Black (Load)

**SERIES 3 MODULAR PLATES WITH MOUNTING FRAMES - SUITABLE FOR METAL BOX**

Module ⇨	1M	2M	3M*	3M	4M*	4M	6M*	6M	8M	8M	8M	12M	12M	16M	18M
						(H&V)**		(H&V)**		(H&V)**	(V)		(H&V)**		
Colours ↓	MRP	MRP	MRP	MRP	MRP	MRP	MRP	MRP	MRP	MRP	MRP	MRP	MRP	MRP	MRP
<b>Natural</b>	111.00	111.00	143.00	143.00	186.00	186.00	250.00	250.00	348.00	348.00	348.00	394.00	394.00	410.00	486.00
<b>Metallic</b>	155.00	155.00	195.00	195.00	260.00	260.00	342.00	342.00	438.00	438.00	438.00	547.00	547.00	555.00	673.00
<b>Wood</b>	182.00	182.00	233.00	233.00	313.00	313.00	410.00	410.00	520.00	520.00	520.00	667.00	667.00	697.00	813.00
<b>PKG</b> ⇨	10/500	10/500	10/400	10/400	10/400	10/400	10/200	10/200	10/200	10/200	10/200	05/120	05/120	05/90	05/80
<b>CODE</b> ⇨	S3 01 11	S3 02 12	S3 03 13	S3 03 25	S3 04 14	S3 04 15	S3 06 16	S3 06 17	S3 08 18	S3 08 19	S3 08 20	S3 12 21	S3 12 22	S3 16 23	S3 18 24
<b>SIZE (mm)</b>	99.5x93	99.5x93	124.5x93	124.5x93	151.5x93	151.5x93	223.5x93	223.5x93	250.5x93	270x93	157.5x163	225.5x163	225.5x163	270x163	225.5x224



\* without Partition Plates \*\* suitable for horizontal & vertical installation

**SERIES 3 MOUNTING FRAMES - HORIZONTAL & VERTICAL FOR FIXING (Dimensions in mm)**

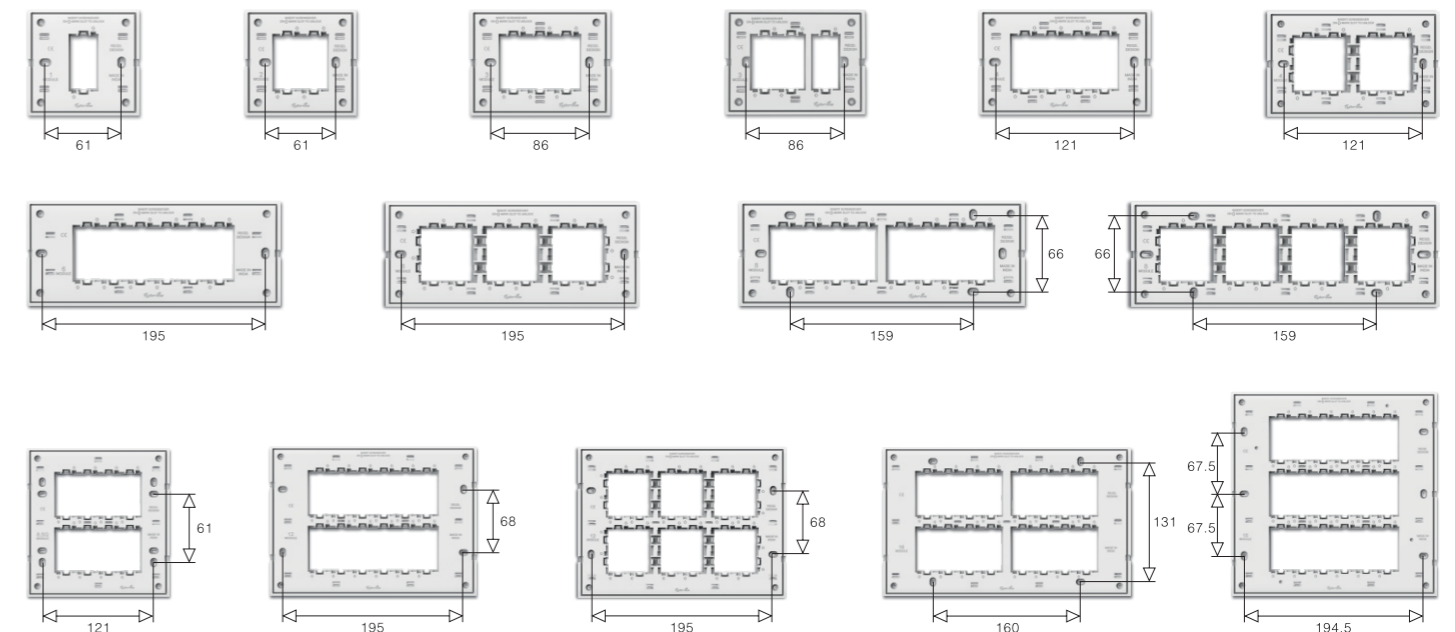

**SERIES 5 MODULAR PLATES WITH MOUNTING FRAMES - SUITABLE FOR METAL BOX**

Module⇨	1M	2M	3M*	3M	4M*	4M	6M*	6M	8M*	8M	8M	12M	12M	16M	18M
					(H&V)**	(H&V)**	(H&V)**	(H&V)**	(H&V)**	(V)	(V)	(H&V)**	(H&V)**		
Colours⇩	MRP	MRP	MRP	MRP	MRP	MRP	MRP	MRP	MRP	MRP	MRP	MRP	MRP	MRP	MRP
Natural	106.00	106.00	135.00	135.00	176.00	176.00	237.00	237.00	348.00	329.00	329.00	376.00	376.00	389.00	463.00
Metallic	148.00	148.00	187.00	187.00	249.00	249.00	326.00	326.00	438.00	416.00	416.00	520.00	520.00	528.00	637.00
Wood	172.00	172.00	222.00	222.00	299.00	299.00	390.00	390.00	520.00	494.00	494.00	636.00	636.00	664.00	774.00
PKG ⇨	10/500	10/500	10/400	10/400	10/400	10/400	10/200	10/200	10/200	10/200	10/200	05/120	05/120	05/90	05/80
CODE ⇨	S5 01 51	S5 02 52	S5 03 53	S5 03 65	S5 04 54	S5 04 55	S5 06 56	S5 06 57	S5 08 58	S5 08 59	S5 08 60	S5 12 61	S5 12 62	S5 16 63	S5 18 64
SIZE (mm)	98x91	98x91	121x91	121x91	152x91	152x91	220x91	220x91	265x91	285x91	152x168	220x157	220x157	270x161	220x222



\* without Partition Plates \*\* suitable for horizontal & vertical installation

**SERIES 5 MOUNTING FRAMES - HORIZONTAL & VERTICAL FOR FIXING (Dimensions in mm)**

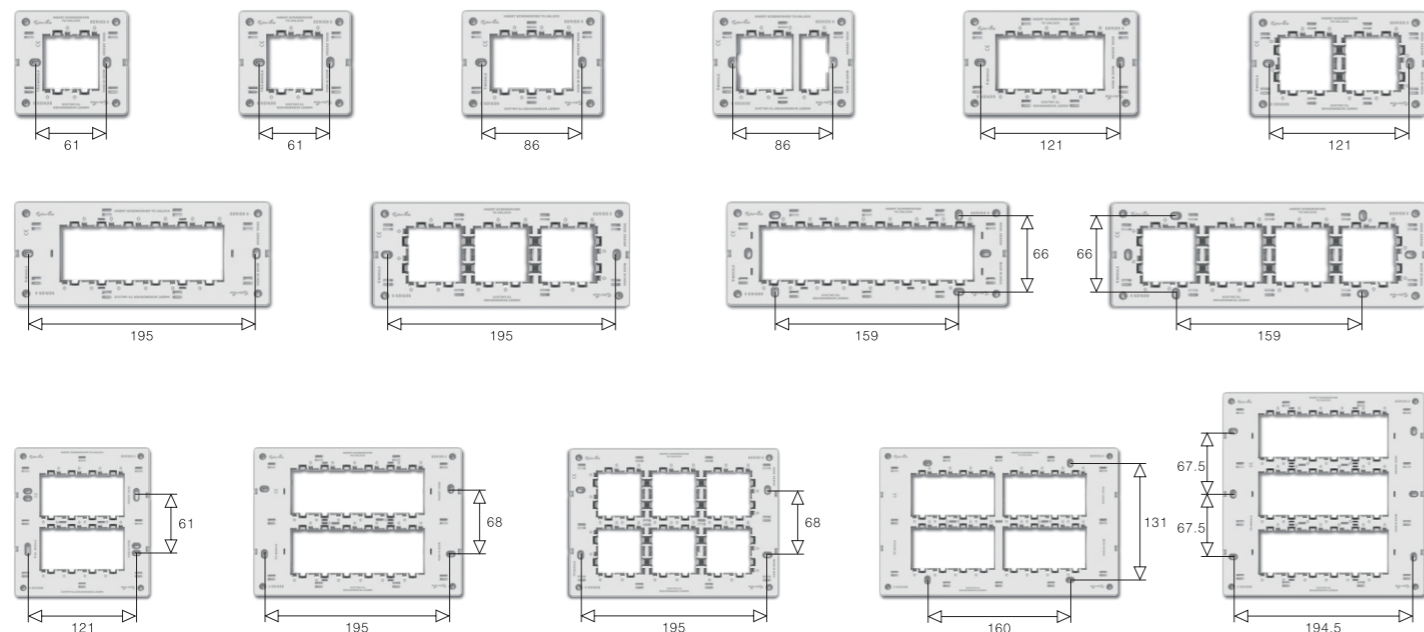

**SERIES 7 WOODEN MODULAR PLATES WITH MOUNTING FRAMES - SUITABLE FOR WOODEN & METAL BOX**

Module⇨	1M	2M	3M*	4M	6M	8M	8M	10M	12M	12M	16M	18M	20M	24M
						(H)	(V)	(H)	(V)	(H)	(V)	(H&V)**	(H&V)**	(H&V)**
Colours⇩	MRP	MRP	MRP	MRP	MRP	MRP	MRP	MRP	MRP	MRP	MRP	MRP	MRP	MRP
Natural	119.00	119.00	149.00	204.00	270.00	321.00	321.00	374.00	421.00	415.00	447.00	540.00	676.00	838.00
Metallic	194.00	194.00	244.00	316.00	438.00	522.00	522.00	608.00	687.00	681.00	732.00	875.00	1102.00	1366.00
Wood	229.00	229.00	289.00	394.00	545.00	654.00	654.00	761.00	861.00	854.00	915.00	1093.00	1374.00	1707.00
PKG ⇨	10/400	10/400	10/400	10/300	10/200	10/200	10/160	10/150	10/120	10/120	10/90	10/80	10/80	10/80
CODE ⇨	S7 01 71	S7 02 72	S7 03 73	S7 04 74	S7 06 75	S7 08 76	S7 08 84	S7 10 77	S7 12 78	S7 12 79	S7 16 80	S7 18 81	S7 20 82	S7 24 83
SIZE (mm)	115x115	115x115	124x115	165x115	221x115	267x115	165x165	317x115	393x115	217x165	267x189	269x215	318x179	318x240

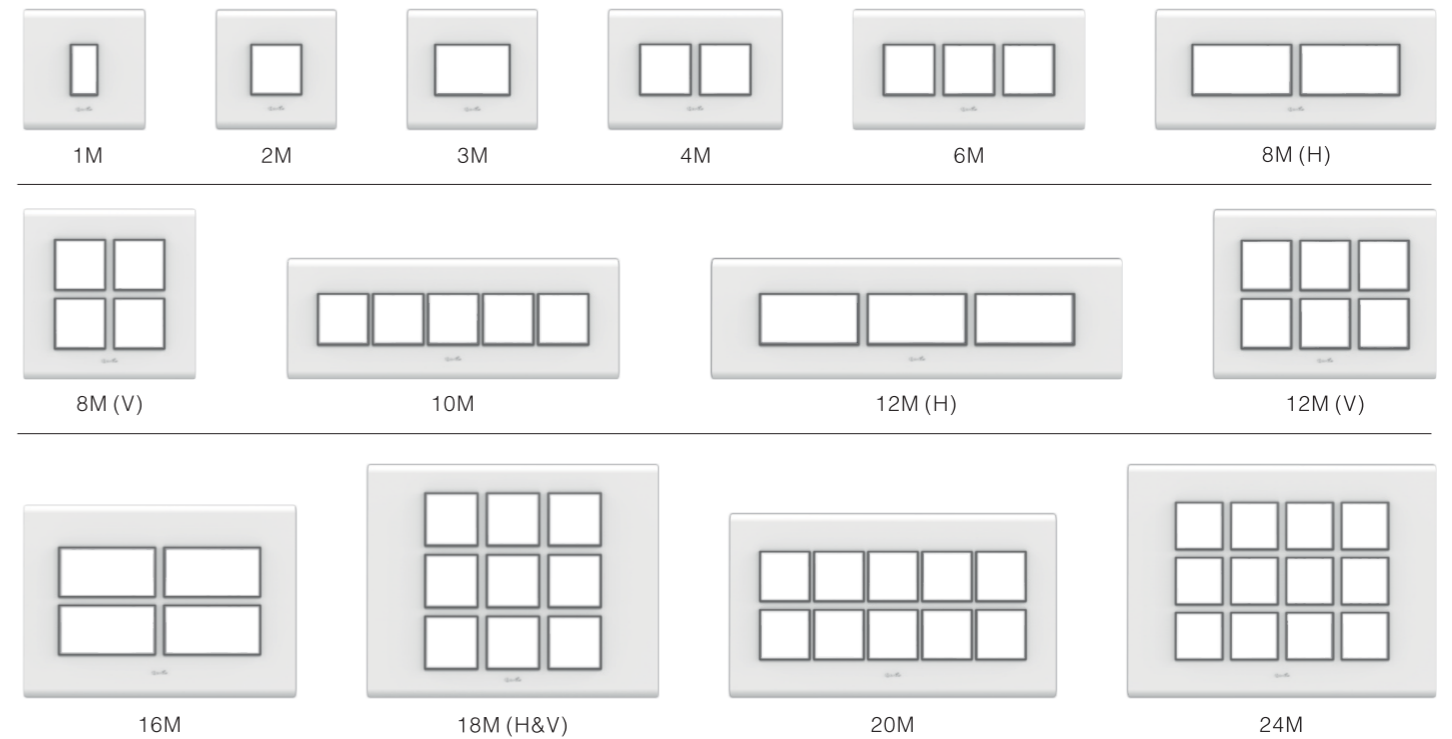

\* without Partition Plates \*\* suitable for horizontal & vertical installation

**SERIES 7 MOUNTING FRAMES - HORIZONTAL & VERTICAL FOR FIXING (Dimensions in mm)**

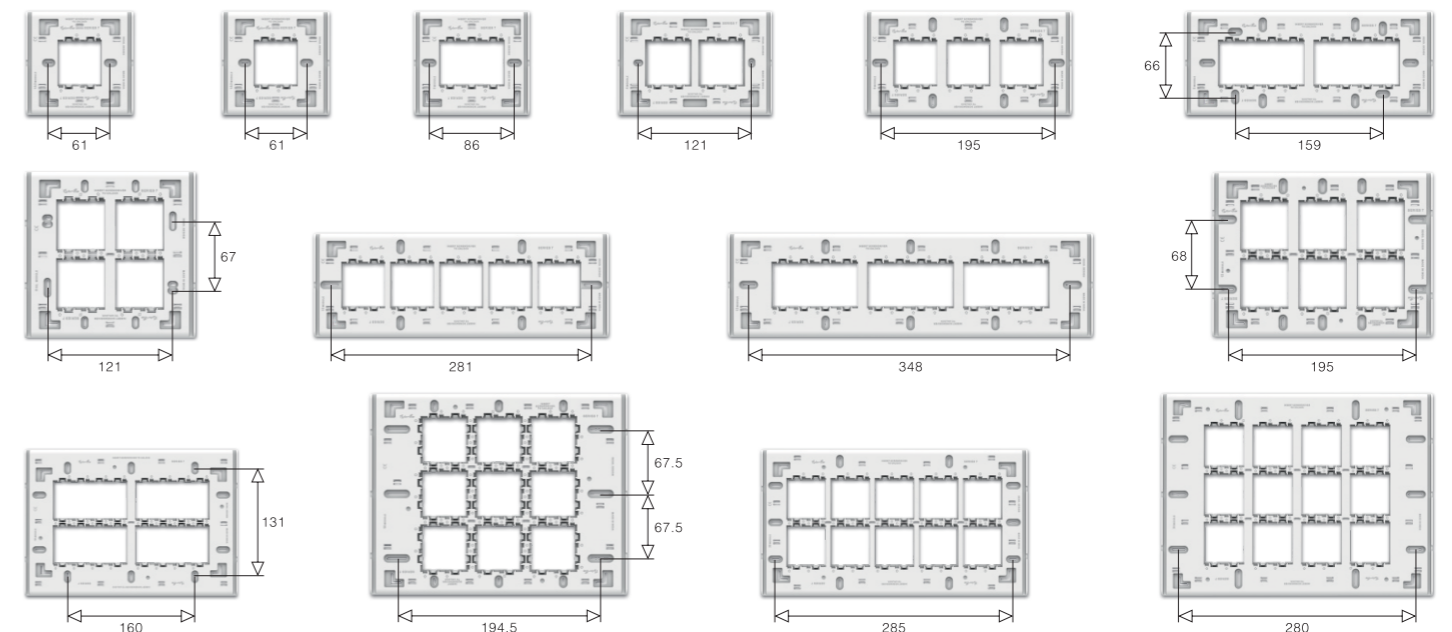

**SERIES 9 GLASS COVER PLATES - SUITABLE FOR METAL BOX (without Frame)**

Module ⇨	1M	2M	3M	4M	6M	8M (H)	8M (V)	12M	16M	18M
Colours ↓	MRP ₹	MRP ₹	MRP ₹	MRP ₹	MRP ₹	MRP ₹	MRP ₹	MRP ₹	MRP ₹	MRP ₹
Glass without Frame	648.00	648.00	914.00	1203.00	1735.00	1949.00	1949.00	2189.00	2517.00	2683.00
PKG ⇨	10/160	10/160	10/160	10/160	05/90	05/90	05/90	05/60	05/40	05/40
CODE ⇨	S9 01 91	S9 02 92	S9 03 93	S9 04 94	S9 06 95	S9 08 96	S9 08 97	S9 12 98	S9 16 100	S9 18 99
SIZE (mm)	106x91	106x91	128x91	152x91	226x91	252x91	152x157	226x157	252x157	226x224

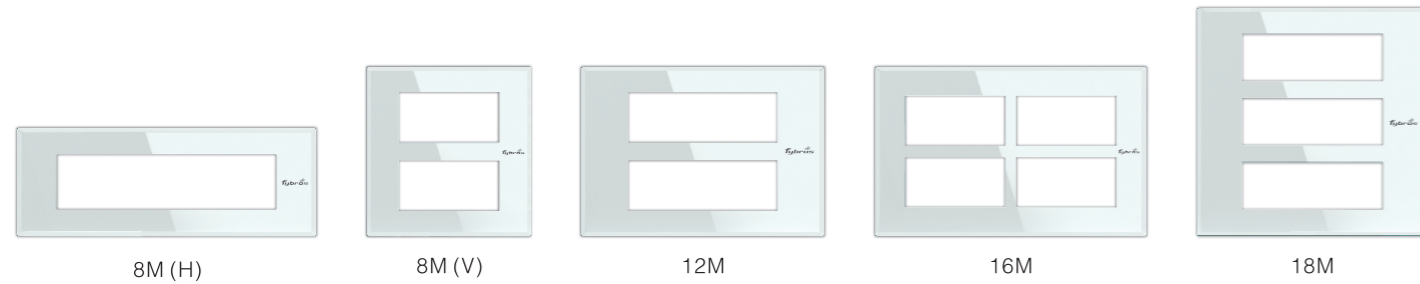

**SERIES 9 MOUNTING FRAMES - HORIZONTAL & VERTICAL FOR FIXING (Dimensions in mm)**

Module ⇨	2M	3M	4M	6M	8M (H)	8M (V)	12M	16M	18M
MRP ₹	75.00	90.00	105.00	154.00	192.00	192.00	247.00	284.00	333.00
PKG ⇨	15/450	15/450	15/300	15/300	10/200	10/200	10/120	10/120	10/80
CODE ⇨	S9 02 102	S9 03 103	S9 04 104	S9 06 105	S9 08 106	S9 08 107	S9 12 108	S9 16 110	S9 18 109

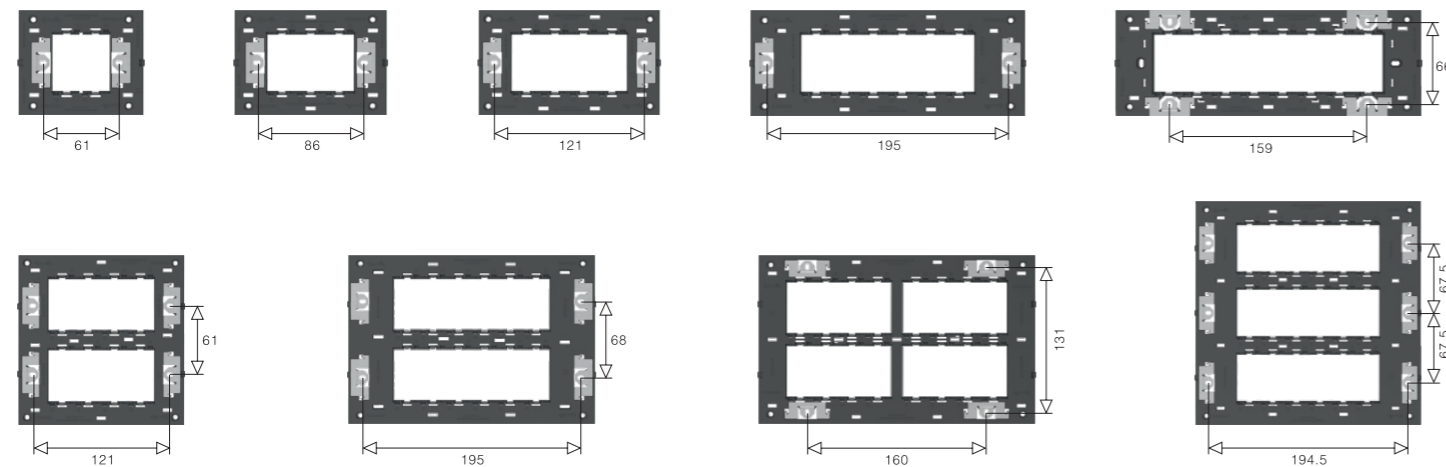

**SERIES 11 MODULAR PLATES WITH MOUNTING FRAMES - SUITABLE FOR METAL BOX**

Module ⇨	1M	2M	3M*	3M	4M*	4M	6M*	6M	8M*	8M	8M	12M	12M	16M	18M
						(H&V)**	(H&V)**	(H&V)**	(V)			(H&V)**			
Colours ↓	MRP	MRP	MRP	MRP	MRP	MRP	MRP	MRP	MRP	MRP	MRP	MRP	MRP	MRP	MRP
Natural	122.00	122.00	155.00	155.00	202.00	202.00	272.00	272.00	379.00	379.00	379.00	431.00	431.00	446.00	531.00
Metallic	172.00	172.00	215.00	215.00	285.00	285.00	375.00	375.00	482.00	482.00	482.00	602.00	602.00	612.00	740.00
Wood	200.00	200.00	255.00	255.00	345.00	345.00	449.00	449.00	571.00	571.00	571.00	734.00	734.00	767.00	895.00
PKG ⇨	10/500	10/500	10/400	10/400	10/400	10/400	10/200	10/200	10/200	10/200	10/200	05/120	05/120	05/90	05/80
CODE ⇨	S1101 31	S1102 32	S1103 33	S1103 45	S1104 34	S1104 35	S1106 36	S1106 37	S1108 38	S1108 39	S1108 40	S1112 41	S1112 42	S1116 43	S1118 44
SIZE (mm)	98x91	98x91	121x91	121x91	152x91	152x91	220x91	220x91	265x91	285x91	152x168	220x157	220x157	270x161	220x222

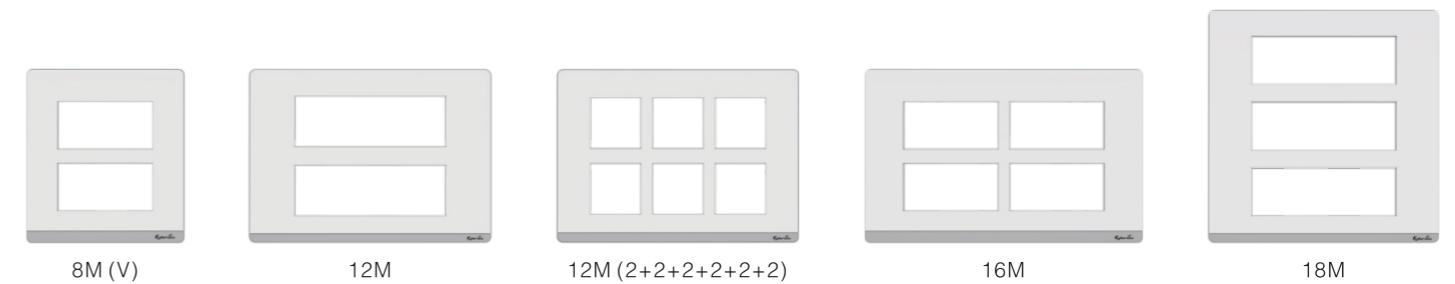

\* without Partition Plates \*\* suitable for horizontal & vertical installation

**SERIES 11 MOUNTING FRAMES - HORIZONTAL & VERTICAL FOR FIXING (Dimensions in mm)**

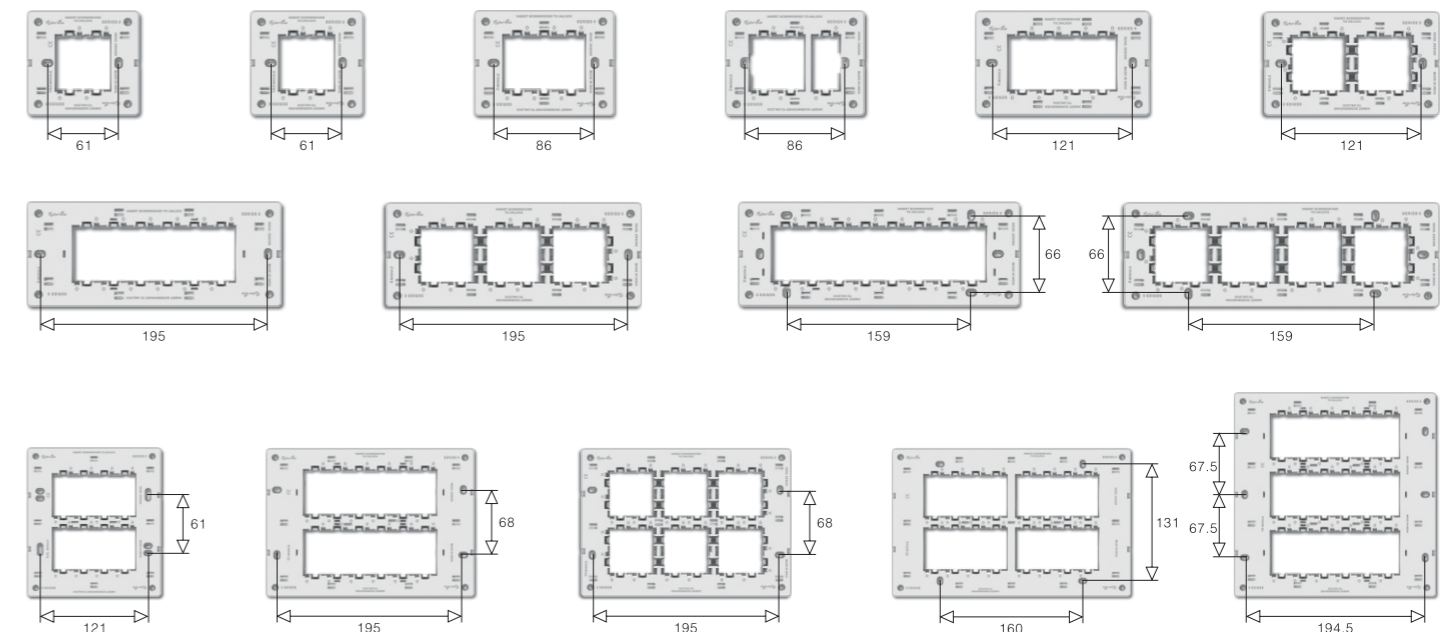

SERIES 15 MODULAR PLATES WITH MOUNTING FRAMES - SUITABLE FOR METAL BOX															
Module	1M	2M	3M*	3M	4M*	4M	6M*	6M	8M	8M	8M	12M	12M	16M	18M
						(H&V)**	(H&V)**	(H&V)**	(H&V)**	(V)	(H&V)**				
Colours	MRP	MRP	MRP	MRP	MRP	MRP	MRP	MRP	MRP	MRP	MRP	MRP	MRP	MRP	MRP
Natural	111.00	111.00	143.00	143.00	186.00	186.00	250.00	250.00	348.00	348.00	348.00	394.00	394.00	410.00	486.00
Metallic	155.00	155.00	195.00	195.00	260.00	260.00	342.00	342.00	438.00	438.00	438.00	547.00	547.00	555.00	673.00
Wood	182.00	182.00	233.00	233.00	313.00	313.00	410.00	410.00	520.00	520.00	520.00	667.00	667.00	697.00	813.00
PKG	10/500	10/500	10/400	10/400	10/400	10/400	10/200	10/200	10/200	10/200	10/200	05/120	05/120	05/90	05/80
CODE	S15 01 251	S15 02 252	S15 03 253	S15 03 265	S15 04 254	S15 04 255	S15 06 256	S15 06 257	S15 08 258	S15 08 259	S15 08 260	S15 12 261	S15 12 262	S15 16 263	S15 18 264
SIZE (mm)	94x91	94x91	119x91	119x91	146x91	146x91	221x91	221x91	243x91	261x91	152x159	220x159	220x159	261x159	221x221



\* without Partition Plates \*\* suitable for horizontal & vertical installation

**SERIES 15 MOUNTING FRAMES - HORIZONTAL & VERTICAL FOR FIXING (Dimensions in mm)**

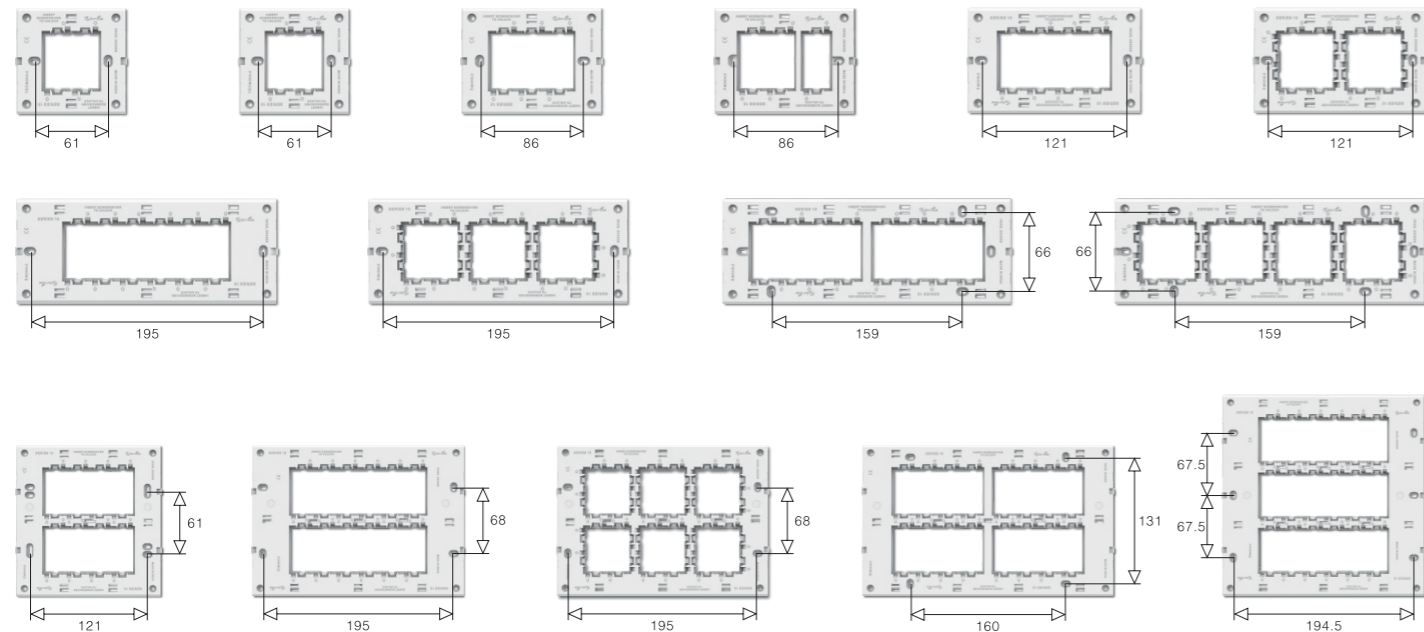

NEWLY INTRODUCED

SURFACE MOUNTING PLASTIC GANG BOXES (FIRE RESISTANT)										
Module	1&2M	3M	4M	6M	8M	8M(W/P)	8M(V)	12M	16M	18M
MRP	78.00	122.00	133.00	169.00	219.00	219.00	219.00	271.00	316.00	370.00
PKG	10 / 240	10 / 120	10 / 120	05 / 80	05 / 80	05 / 80	05 / 60	05 / 60	05 / 40	05 / 40
CODE	SB 02 22	SB 03 23	SB 04 24	SB 06 25	SB 08 26	SB 08 27	SB 08 28	SB 12 29	SB 16 30	SB 18 31
SIZE (LxHxW) mm	103x93x50	130x93x50	158x93x50	225x93x50	268x93x50	242x93x50	158x160x50	225x160x50	268x160x50	225x227x50

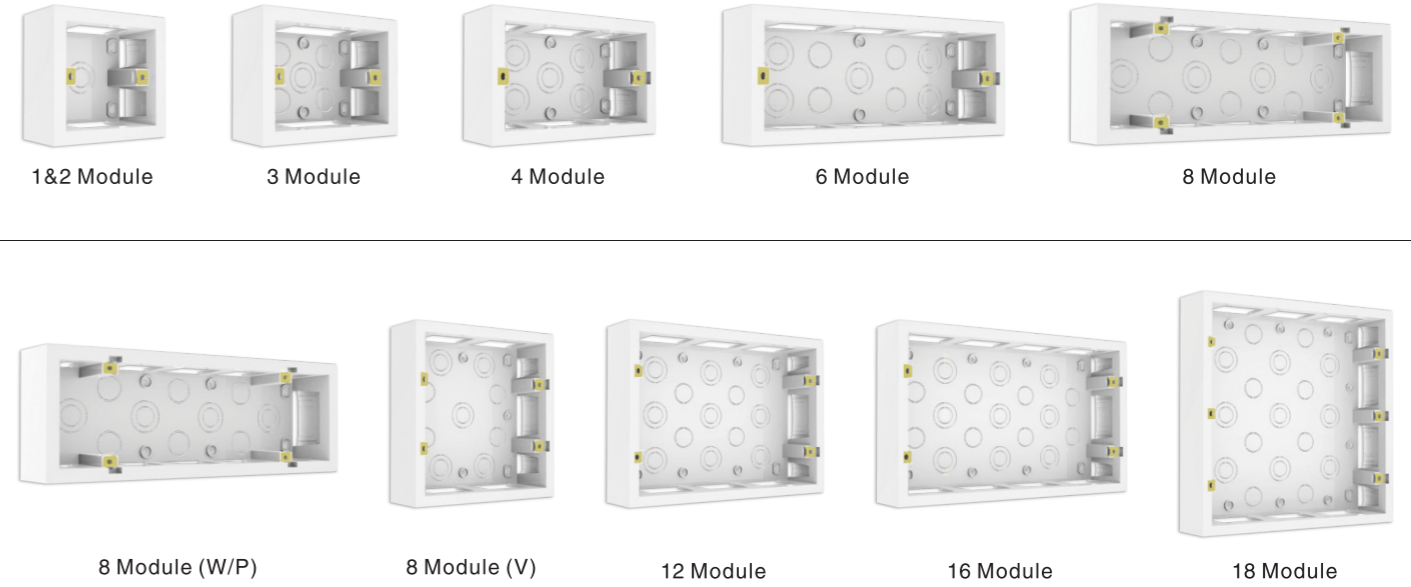

NUEVO METAL GANG BOXES <b>NEW</b>										
Module	1&2M	3M	4M	6M	8M (H)	8M(V)	12M	16M	18M	
MRP	88.00	107.00	122.00	176.00	217.00	217.00	270.00	338.00	383.00	
PKG	20 / 120	20 / 120	20 / 120	10 / 80	10 / 80	05 / 60	05 / 40	05 / 40	05 / 40	
CODE	V5001	V5002	V5003	V5004	V5005	V5006	V5007	V5008	V5009	
SIZE (LxHxW) mm	75x75x52	103x75x52	139x75x52	212x75x54	236x79x54	137x133x60	211x132x60	231x146x60	210x202x60	

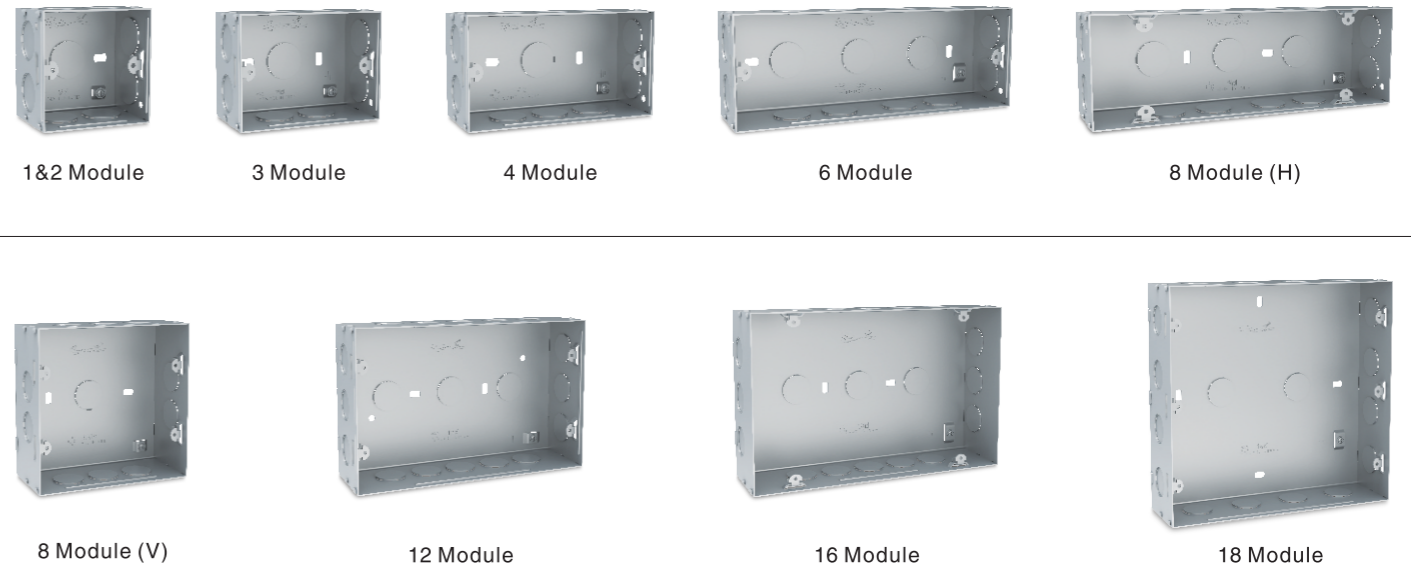

NEWLY INTRODUCED

ACURE METAL GANG BOXES		NEW								
Module	⇨	1&2M	3M	4M	6M	8M(H)	8M(V)	12M	16M	18M
MRP		99.00	120.00	137.00	197.00	243.00	243.00	302.00	379.00	429.00
PKG	⇨	20 / 120	20 / 120	20 / 120	10 / 80	10 / 80	05 / 60	05 / 40	05 / 40	05 / 40
CODE	⇨	V3001	V3002	V3003	V3004	V3005	V3006	V3007	V3008	V3009
SIZE (LxHxW) mm		75x75x52	103x75x52	139x75x52	212x75x54	236x79x54	137x133x60	211x132x60	231x146x60	210x202x60

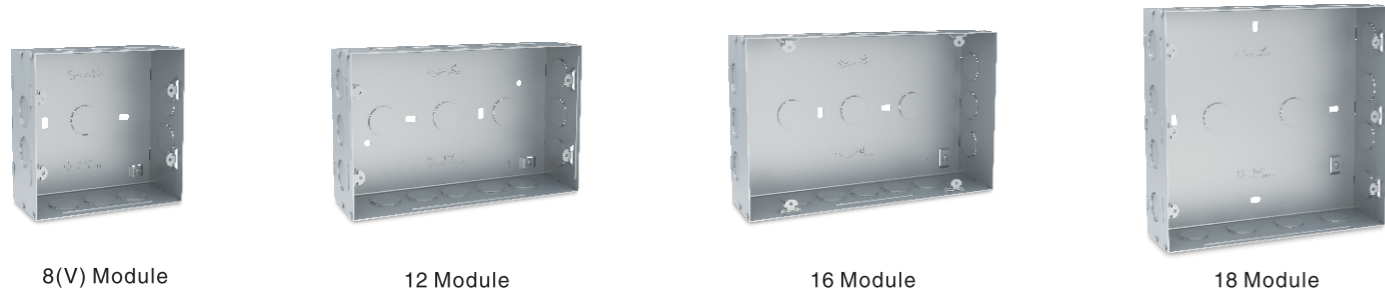

**SERIES**  
MODULAR PLATE

Natural



01- Pure White

Metallic



02- Emerald Chrome

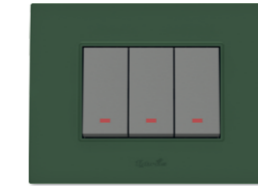

03- Emerald Green\* (NEW)

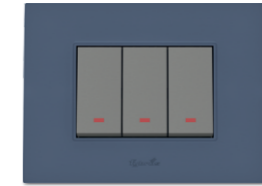

04- Sapphire Blue\* (NEW)

Wood



05- Mapple Wood

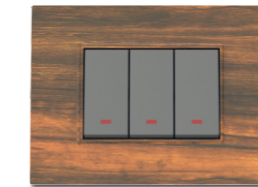

06- Café Pine

**SERIES**  
GLASS PLATE

Glass



01- Chiffon White

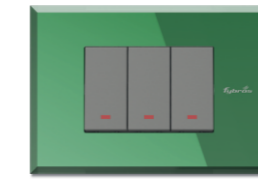

02- Forest Green



03- Ruby Wine



04- Coal Black



05- Frost White



06- Fossil Grey



07- Mocha Brown



08- Polished Chrome

Mirror Finish

**SERIES 5**  
MODULAR PLATE

Natural



01- Snow White

Metallic

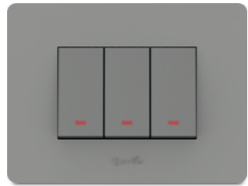

02- Metalik Chrome

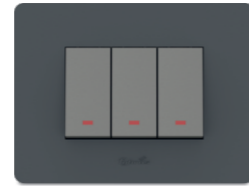

03- Velvet Grey



04- Onyx Black

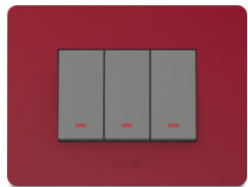

05- Cherry Red

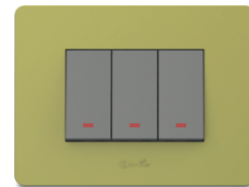

06- Aqua Green

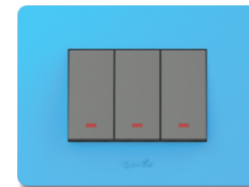

07- Aqua Blue

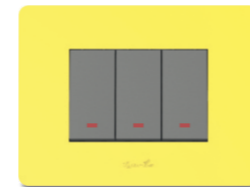

08- Majestic Yellow

Wood

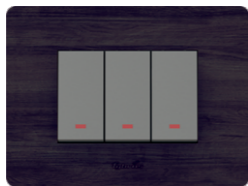

09- Teak Wood\* (NEW)

**SERIES 7**  
WOODEN PLATE

Natural



01- Shimmer White

Metallic



02- Alloy Chrome

Wood



03- Shady Wood

**SERIES 11**  
MODULAR PLATE

Natural



01- Dove White

Metallic



02- Lava Chrome

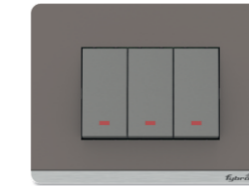

03- Khaki Mud

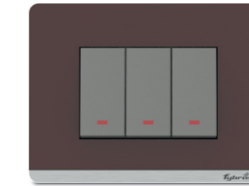

04- Rich Umber



05- Jade Black

Wood

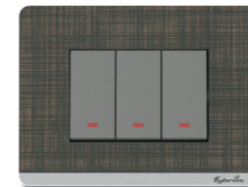

06- Espresso Wood



07- Dark Walnut

**SERIES 15** NEW  
MODULAR PLATE

Natural



01- Lunar White

Metallic



02- Graphite Chrome

Wood



03- American Walnut

# LIME LIGHT ON THE WALLS



CRYSTAL 5 STEP FAN REGULATOR 2M & PLANA ONE WAY SWITCH WITH INDICATOR 1M  
A-NINE BASIC PREMIUM 4M PLATE

A-NINE BASIC IVORY 4M PLATE  
MINI LED FOOT LIGHT 2M & PLANA ONE WAY SWITCH WITH INDICATOR 1M



**A-NINE**  
MODULAR PLATES

A-NINE ACCENTUATES A STYLE QUOTIENT FOR YOUR WALLS WITH THEIR DISTINCTIVELY SLENDER APPEARANCE. PAINSTAKINGLY CRAFTED AND POLISHED TO PERFECTION, THE SWITCHES ARE AN EPITOME OF PANACHE. SO, MAKE A STYLE STATEMENT THAT WILL ALWAYS BE IN VOGUE.

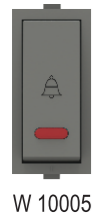
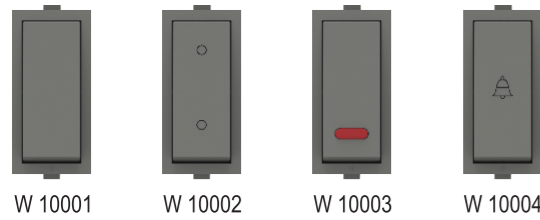

CODE	ITEM	MRP(Rs.)	PURE WHITE	METALLIC CHROME/BLACK	PKG OUTER / MASTER
<b>WOOD-em 10 Amp. RAZE SWITCHES</b>					
W 10001	1 Way Switch		48.00	62.00	20 / 1200
W 10002	2 Way Switch		77.00	90.00	20 / 1200
W 10003	1 Way Switch with Indicator		81.00	94.00	20 / 1200
W 10004	Bell Push		81.00	94.00	20 / 1200
W 10005	Bell Push with Indicator		89.00	100.00	20 / 1200

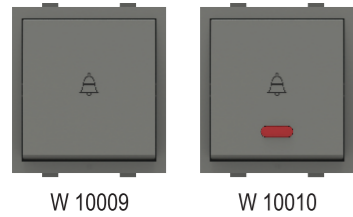
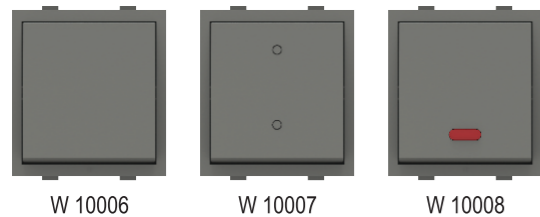

<b>WOOD-em 10 Amp. RAZE GAMA SWITCHES</b>					
W 10006	1 Way Switch		84.00	103.00	10 / 450
W 10007	2 Way Switch		96.00	116.00	10 / 450
W 10008	1 Way Switch with Indicator		96.00	116.00	10 / 450
W 10009	Bell Push		96.00	116.00	10 / 450
W 10010	Bell Push with Indicator		103.00	123.00	10 / 450

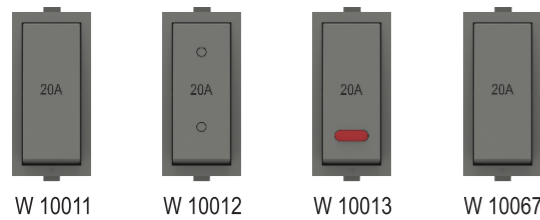

<b>WOOD-em 20 Amp. RAZE SWITCHES</b>					
W 10011	1 Way Switch		90.00	97.00	20 / 1200
W 10012	2 Way Switch		110.00	123.00	20 / 1200
W 10013	1 Way Switch with Indicator		106.00	111.00	20 / 1200
W 10067	1 Way Switch (Porcelain)		88.00	97.00	10 / 600

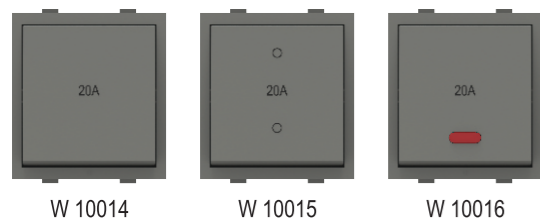

<b>WOOD-em 20 Amp. RAZE GAMA SWITCHES</b>					
W 10014	1 Way Switch		116.00	136.00	10 / 450
W 10015	2 Way Switch		123.00	142.00	10 / 450
W 10016	1 Way Switch with Indicator		123.00	142.00	10 / 450



<b>WOOD-em RAZE POWER SWITCHES</b>					
W 10018	32 Amp. DP Switch with Indicator (Heavy Duty Double Pole Main Switch)		232.00	253.00	10 / 450

CODE	ITEM	MRP(Rs.)	PURE WHITE	METALLIC CHROME/BLACK	PKG OUTER / MASTER
<b>WOOD-em 10 Amp. PLANA SWITCHES</b>					
W 90001	1 Way Switch		59.00	71.00	20 / 1200
W 90002	2 Way Switch		84.00	97.00	20 / 1200
W 90003	1 Way Switch with Indicator		89.00	102.00	20 / 1200
W 90004	Bell Push		89.00	102.00	20 / 1200
W 90005	Bell Push with Indicator		97.00	110.00	20 / 1200

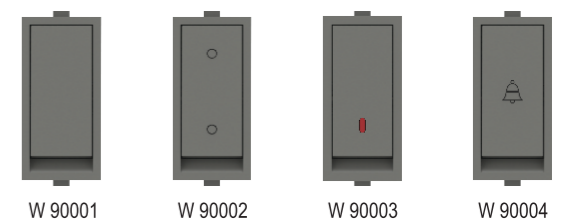

<b>WOOD-em 10 Amp. PLANA GAMA SWITCHES</b>					
W 90006	1 Way Switch		96.00	116.00	10 / 450
W 90016*	2 Way Switch (New)		110.00	129.00	10 / 450
W 90007	1 Way Switch with Indicator		110.00	129.00	10 / 450
W 90008	Bell Push with Indicator		116.00	136.00	10 / 450

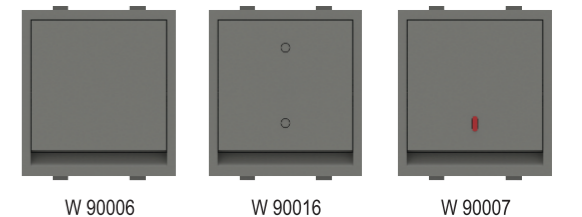

<b>WOOD-em 20 Amp. PLANA SWITCHES</b>					
W 90009	1 Way Switch		100.00	105.00	20 / 1200
W 90010	2 Way Switch		117.00	131.00	20 / 1200
W 90011	1 Way Switch with Indicator		113.00	118.00	20 / 1200

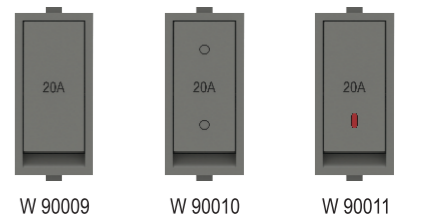

<b>WOOD-em 20 Amp. PLANA GAMA SWITCHES</b>					
W 90012	1 Way Switch		128.00	146.00	10 / 450
W 90013	2 Way Switch		136.00	156.00	10 / 450
W 90014	1 Way Switch with Indicator		136.00	156.00	10 / 450

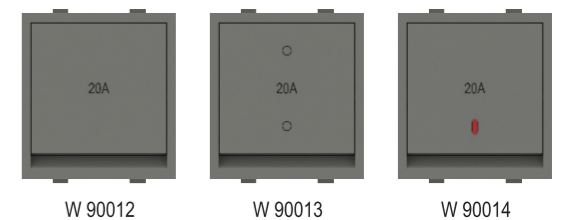

<b>WOOD-em PLANA POWER SWITCHES</b>					
W 90015	32 Amp. DP Switch with Indicator (Heavy Duty Double Pole Main Switch)		257.00	276.00	10 / 450



\* NEWLY INTRODUCED

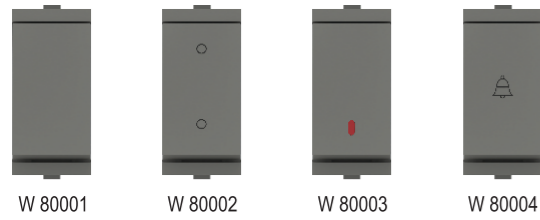

CODE	ITEM	MRP(Rs.)	PURE WHITE	METALLIC CHROME/BLACK	PKG OUTER / MASTER
<b>WOOD-em 10 Amp. AURA SWITCHES</b>					
W 80001	1 Way Switch		59.00	79.00	20 / 1200
W 80002	2 Way Switch		84.00	103.00	20 / 1200
W 80003	1 Way Switch with Indicator		89.00	109.00	20 / 1200
W 80004	Bell Push		89.00	109.00	20 / 1200
W 80005	Bell Push with Indicator		97.00	115.00	20 / 1200



CODE	ITEM	MRP(Rs.)	PURE WHITE	METALLIC CHROME/BLACK	PKG OUTER / MASTER
<b>WOOD-em 10 Amp. AURA GAMA SWITCHES</b>					
W 80006	1 Way Switch		96.00	123.00	10 / 450
W 80007	1 Way Switch with Indicator		110.00	134.00	10 / 450
W 80008	Bell Push with Indicator		116.00	140.00	10 / 450

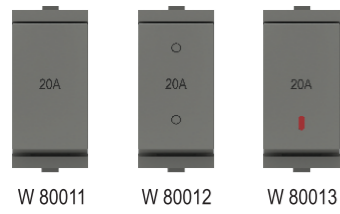

CODE	ITEM	MRP(Rs.)	PURE WHITE	METALLIC CHROME/BLACK	PKG OUTER / MASTER
<b>WOOD-em 20 Amp. AURA SWITCHES</b>					
W 80011	1 Way Switch		100.00	112.00	20 / 1200
W 80012	2 Way Switch		117.00	139.00	20 / 1200
W 80013	1 Way Switch with Indicator		113.00	132.00	20 / 1200

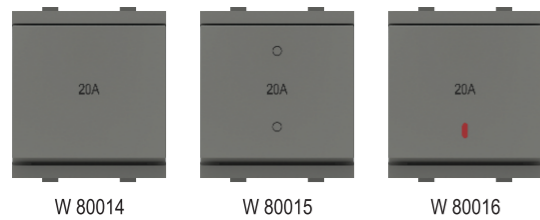

CODE	ITEM	MRP(Rs.)	PURE WHITE	METALLIC CHROME/BLACK	PKG OUTER / MASTER
<b>WOOD-em 20 Amp. AURA GAMA SWITCHES</b>					
W 80014	1 Way Switch		128.00	150.00	10 / 450
W 80015	2 Way Switch		136.00	160.00	10 / 450
W 80016	1 Way Switch with Indicator		136.00	160.00	10 / 450



CODE	ITEM	MRP(Rs.)	PURE WHITE	METALLIC CHROME/BLACK	PKG OUTER / MASTER
<b>WOOD-em AURA POWER SWITCHES</b>					
W 80018	32 Amp. DP Switch with Indicator (Heavy Duty Double Pole Main Switch)		257.00	282.00	10 / 450

CODE	ITEM	MRP(Rs.)	PURE WHITE	METALLIC CHROME/BLACK	PKG OUTER / MASTER
<b>WOOD-em 10 Amp. SLIM SWITCHES</b>					
W 90051	1 Way Switch		67.00	81.00	20 / 1200
W 90052	2 Way Switch		94.00	107.00	20 / 1200
W 90053	1 Way Switch with Indicator		99.00	112.00	20 / 1200
W 90054	Bell Push		99.00	112.00	20 / 1200
W 90055	Bell Push with Indicator		110.00	123.00	20 / 1200

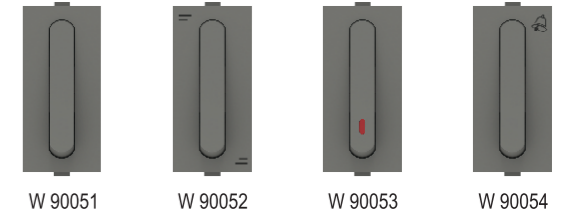

CODE	ITEM	MRP(Rs.)	PURE WHITE	METALLIC CHROME/BLACK	PKG OUTER / MASTER
<b>WOOD-em 10 Amp. SLIM GAMA SWITCHES</b>					
W 90056	1 Way Switch		106.00	126.00	10 / 450
W 90057	1 Way Switch with Indicator		119.00	139.00	10 / 450
W 90058	Bell Push with Indicator		124.00	143.00	10 / 450

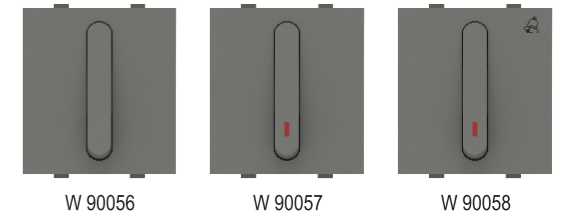

CODE	ITEM	MRP(Rs.)	PURE WHITE	METALLIC CHROME/BLACK	PKG OUTER / MASTER
<b>WOOD-em 20 Amp. SLIM SWITCHES</b>					
W 90059	1 Way Switch		105.00	116.00	20 / 1200
W 90060	2 Way Switch		130.00	143.00	20 / 1200
W 90061	1 Way Switch with Indicator		124.00	136.00	20 / 1200

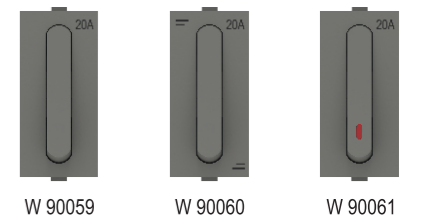

CODE	ITEM	MRP(Rs.)	PURE WHITE	METALLIC CHROME/BLACK	PKG OUTER / MASTER
<b>WOOD-em 20 Amp. SLIM GAMA SWITCHES</b>					
W 90062	1 Way Switch		138.00	157.00	10 / 450
W 90063	2 Way Switch		145.00	165.00	10 / 450
W 90064	1 Way Switch with Indicator		145.00	165.00	10 / 450

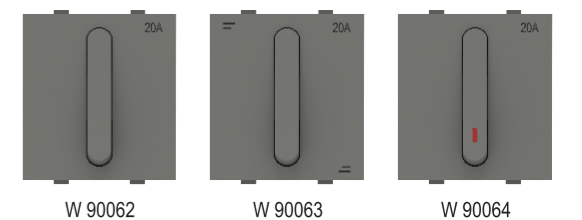

CODE	ITEM	MRP(Rs.)	PURE WHITE	METALLIC CHROME/BLACK	PKG OUTER / MASTER
<b>WOOD-em SLIM POWER SWITCHES</b>					
W 90065	32 Amp. DP Switch with Indicator (Heavy Duty Double Pole Main Switch)		268.00	286.00	10 / 450



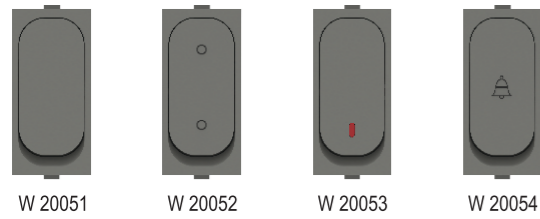

CODE	ITEM	MRP(Rs.)	PURE WHITE	METALLIC CHROME/BLACK	PKG OUTER / MASTER
<b>WOOD-em 10 Amp. ARC SWITCHES</b>					
W 20051	1 Way Switch		59.00	71.00	20 / 1200
W 20052	2 Way Switch		84.00	97.00	20 / 1200
W 20053	1 Way Switch with Indicator		89.00	102.00	20 / 1200
W 20054	Bell Push		89.00	102.00	20 / 1200
W 20055	Bell Push with Indicator		97.00	110.00	20 / 1200

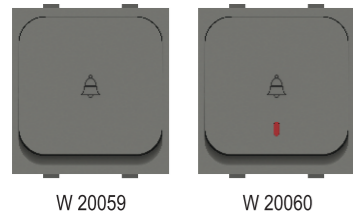
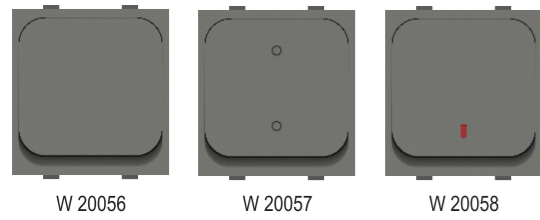

CODE	ITEM	MRP(Rs.)	PURE WHITE	METALLIC CHROME/BLACK	PKG OUTER / MASTER
<b>WOOD-em 10 Amp. ARC GAMA SWITCHES</b>					
W 20056	1 Way Switch		96.00	116.00	10 / 450
W 20057	2 Way Switch		110.00	129.00	10 / 450
W 20058	1 Way Switch with Indicator		110.00	129.00	10 / 450
W 20059	Bell Push		110.00	129.00	10 / 450
W 20060	Bell Push with Indicator		116.00	136.00	10 / 450

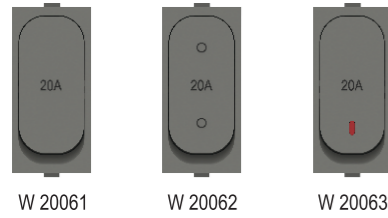

CODE	ITEM	MRP(Rs.)	PURE WHITE	METALLIC CHROME/BLACK	PKG OUTER / MASTER
<b>WOOD-em 20 Amp. ARC SWITCHES</b>					
W 20061	1 Way Switch		100.00	105.00	20 / 1200
W 20062	2 Way Switch		117.00	131.00	20 / 1200
W 20063	1 Way Switch with Indicator		113.00	118.00	20 / 1200

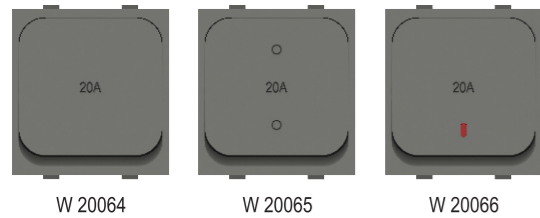

CODE	ITEM	MRP(Rs.)	PURE WHITE	METALLIC CHROME/BLACK	PKG OUTER / MASTER
<b>WOOD-em 20 Amp. ARC GAMA SWITCHES</b>					
W 20064	1 Way Switch		128.00	146.00	10 / 450
W 20065	2 Way Switch		136.00	156.00	10 / 450
W 20066	1 Way Switch with Indicator		136.00	156.00	10 / 450



CODE	ITEM	MRP(Rs.)	PURE WHITE	METALLIC CHROME/BLACK	PKG OUTER / MASTER
<b>WOOD-em ARC POWER SWITCHES</b>					
W 20067	32 Amp. DP Switch with Indicator (Heavy Duty Double Pole Main Switch)		257.00	276.00	10 / 450

CODE	ITEM	MRP(Rs.)	PURE WHITE	METALLIC CHROME/BLACK	PKG OUTER / MASTER
<b>WOOD-em 10 Amp. CHARM SWITCHES</b> <span style="color: red;">NEW</span>					
W 80051	1 Way Switch		59.00	71.00	20 / 1200
W 80052	2 Way Switch		84.00	97.00	20 / 1200
W 80053	1 Way Switch with Indicator		89.00	102.00	20 / 1200
W 80054	Bell Push		89.00	102.00	20 / 1200
W 80055	Bell Push with Indicator		97.00	110.00	20 / 1200

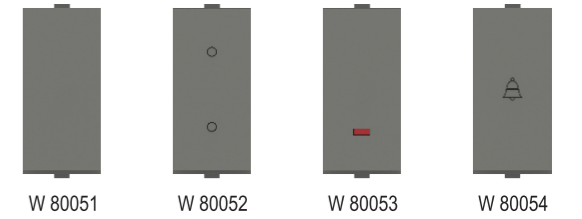

CODE	ITEM	MRP(Rs.)	PURE WHITE	METALLIC CHROME/BLACK	PKG OUTER / MASTER
<b>WOOD-em 10 Amp. CHARM GAMA SWITCHES</b> <span style="color: red;">NEW</span>					
W 80056	1 Way Switch		96.00	116.00	10 / 450
W 80057	2 Way Switch		110.00	129.00	10 / 450
W 80058	1 Way Switch with Indicator		110.00	129.00	10 / 450
W 80059	Bell Push		110.00	129.00	10 / 450
W 80060	Bell Push with Indicator		116.00	136.00	10 / 450

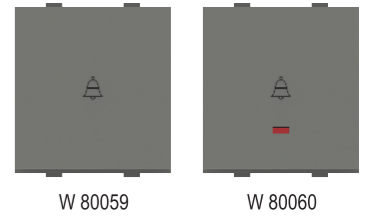
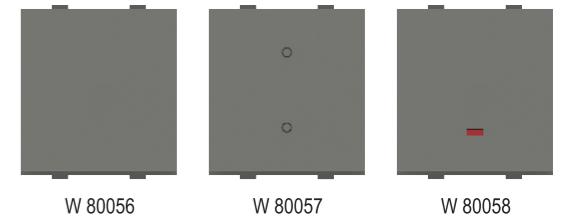

CODE	ITEM	MRP(Rs.)	PURE WHITE	METALLIC CHROME/BLACK	PKG OUTER / MASTER
<b>WOOD-em 20 Amp. CHARM SWITCHES</b> <span style="color: red;">NEW</span>					
W 80061	1 Way Switch		100.00	105.00	20 / 1200
W 80062	2 Way Switch		117.00	131.00	20 / 1200
W 80063	1 Way Switch with Indicator		113.00	118.00	20 / 1200

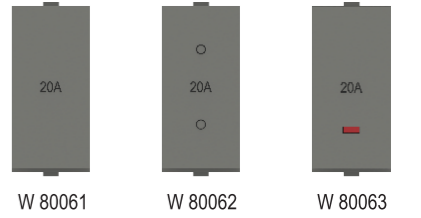

CODE	ITEM	MRP(Rs.)	PURE WHITE	METALLIC CHROME/BLACK	PKG OUTER / MASTER
<b>WOOD-em 20 Amp. CHARM GAMA SWITCHES</b> <span style="color: red;">NEW</span>					
W 80064	1 Way Switch		128.00	146.00	10 / 450
W 80065	2 Way Switch		136.00	156.00	10 / 450
W 80066	1 Way Switch with Indicator		136.00	156.00	10 / 450

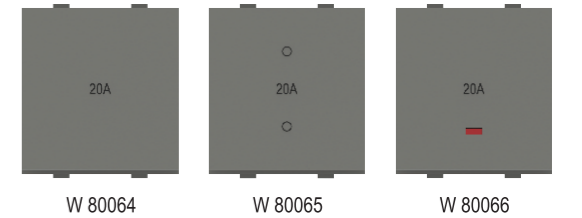

CODE	ITEM	MRP(Rs.)	PURE WHITE	METALLIC CHROME/BLACK	PKG OUTER / MASTER
<b>WOOD-em CHARM POWER SWITCHES</b> <span style="color: red;">NEW</span>					
W 80067	32 Amp. DP Switch with Indicator (Heavy Duty Double Pole Main Switch)		257.00	276.00	10 / 450



NEWLY INTRODUCED

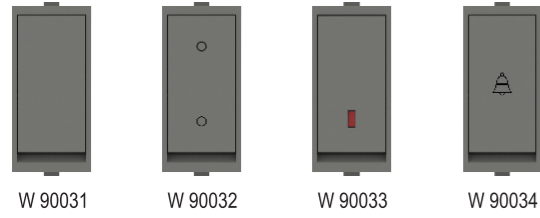

CODE	ITEM	MRP(Rs.)	PURE WHITE	METALLIC CHROME/BLACK	PKG OUTER / MASTER
<b>WOOD-em 10 Amp. PRIME SWITCHES</b>					
W 90031	1 Way Switch		59.00	71.00	20 / 1200
W 90032	2 Way Switch		84.00	97.00	20 / 1200
W 90033	1 Way Switch with Indicator		89.00	102.00	20 / 1200
W 90034	Bell Push		89.00	102.00	20 / 1200
W 90035	Bell Push with Indicator		97.00	110.00	20 / 1200

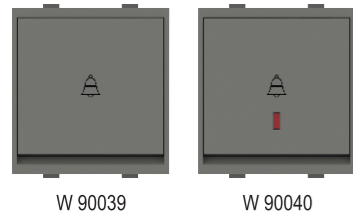
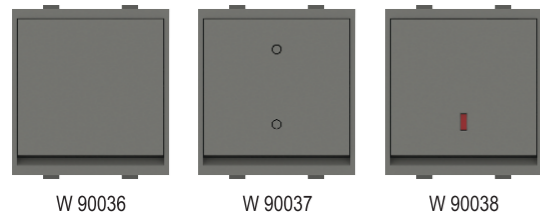

CODE	ITEM	MRP(Rs.)	PURE WHITE	METALLIC CHROME/BLACK	PKG OUTER / MASTER
<b>WOOD-em 10 Amp. PRIME GAMA SWITCHES</b>					
W 90036	1 Way Switch		96.00	116.00	10 / 450
W 90037	2 Way Switch		110.00	129.00	10 / 450
W 90038	1 Way Switch with Indicator		110.00	129.00	10 / 450
W 90039	Bell Push		110.00	129.00	10 / 450
W 90040	Bell Push with Indicator		116.00	136.00	10 / 450

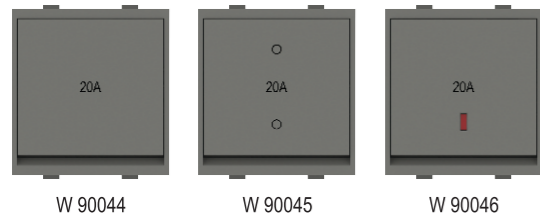
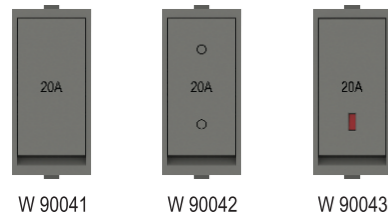

CODE	ITEM	MRP(Rs.)	PURE WHITE	METALLIC CHROME/BLACK	PKG OUTER / MASTER
<b>WOOD-em 20 Amp. PRIME SWITCHES</b>					
W 90041	1 Way Switch		100.00	105.00	20 / 1200
W 90042	2 Way Switch		117.00	131.00	20 / 1200
W 90043	1 Way Switch with Indicator		113.00	118.00	20 / 1200
<b>WOOD-em 20 Amp. PRIME GAMA SWITCHES</b>					
W 90044	1 Way Switch		128.00	146.00	10 / 450
W 90045	2 Way Switch		136.00	156.00	10 / 450
W 90046	1 Way Switch with Indicator		136.00	156.00	10 / 450



CODE	ITEM	MRP(Rs.)	PURE WHITE	METALLIC CHROME/BLACK	PKG OUTER / MASTER
<b>WOOD-em PRIME POWER SWITCHES</b>					
W 90047	32 Amp. DP Switch with Indicator (Heavy Duty Double Pole Main Switch)		257.00	276.00	10 / 450

CODE	ITEM	MRP(Rs.)	PURE WHITE	METALLIC CHROME/BLACK	PKG OUTER / MASTER
<b>WOOD-em 6Amp. / 13Amp. SOCKETS</b>					
W 10019	6 Amp. 2 Pin Socket with Safety Shutter		76.00	90.00	20 / 1200
W 10020	6 Amp. 2 in 1 Socket		91.00	102.00	10 / 600
W 10062	6Amp. 3 Pin Socket		91.00	102.00	10 / 600
W 10022	13 Amp. International Socket with Safety Shutter		142.00	161.00	10 / 450

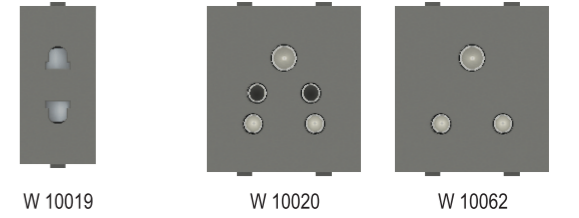

CODE	ITEM	MRP(Rs.)	PURE WHITE	METALLIC CHROME/BLACK	PKG OUTER / MASTER
<b>WOOD-em 6&amp;16Amp. SOCKETS with SAFETY SHUTTER</b>					
W 10023	6&16A Universal Socket with Safety Shutter		143.00	155.00	10 / 450
W 10024	6&16A Universal Power Socket with Safety Shutter		180.00	201.00	10 / 450
W 10058	6&16A Raised Socket with Safety Shutter		143.00	155.00	10 / 450
W 10060	6&16A Raised Power Socket with Safety Shutter		180.00	201.00	10 / 450
W 10068	6&16A Universal Socket (Porcelain)		143.00	155.00	10 / 300

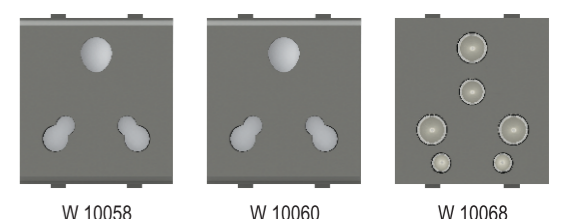
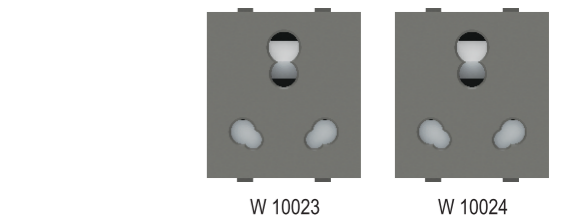

CODE	ITEM	MRP(Rs.)	PURE WHITE	METALLIC CHROME/BLACK	PKG OUTER / MASTER
<b>WOOD-em ELECTRONIC DIMMERS / REGULATORS</b>					
W 10026	GLAZE Mini Dimmer		223.00	236.00	10 / 600
W 10027	GLAZE Medium Dimmer		298.00	316.00	10 / 450
W 10028	GLAZE EME 4 Step Fan Regulator		313.00	318.00	10 / 600
W 10029	GLAZE EME 5 Step Fan Regulator		350.00	357.00	10 / 450
W 10053	EME 5 Step WEGA Fan Regulator - Full Rotary		350.00	357.00	10 / 450
W 10054	CRYSTAL Mini Dimmer		223.00	236.00	10 / 600
W 10055	CRYSTAL Medium Dimmer		298.00	316.00	10 / 450
W 10056	CRYSTAL 4 Step Fan Regulator - Full Rotary		313.00	318.00	10 / 600
W 10057	CRYSTAL 5 Step Fan Regulator - Full Rotary		350.00	357.00	10 / 450
W 10072	CRYSTAL 8 Step Fan Regulator - Full Rotary		350.00	368.00	10 / 450

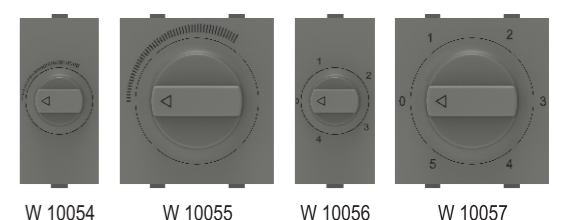
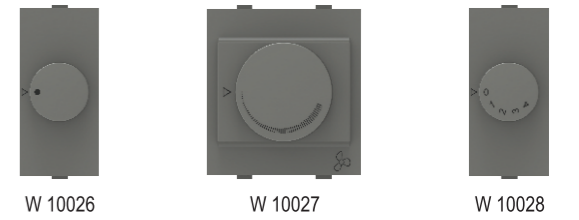

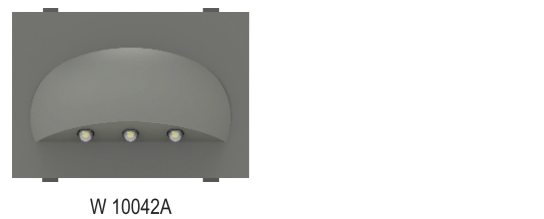
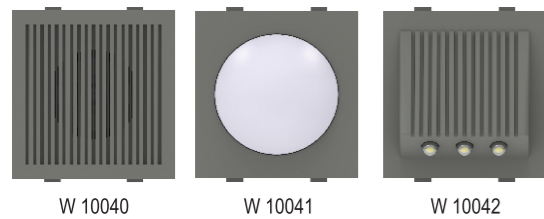
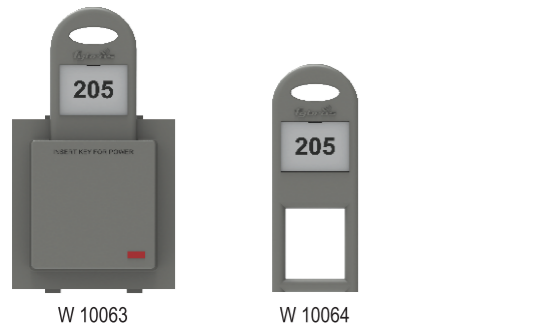
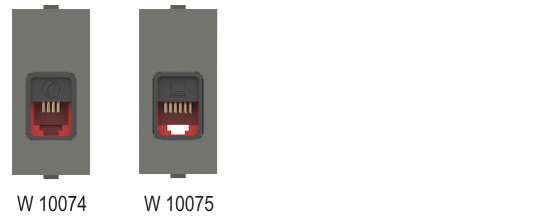
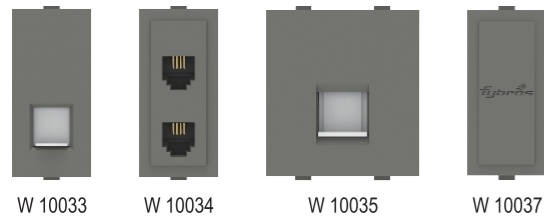
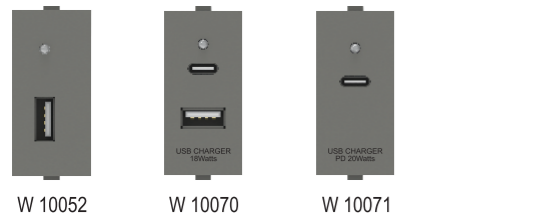
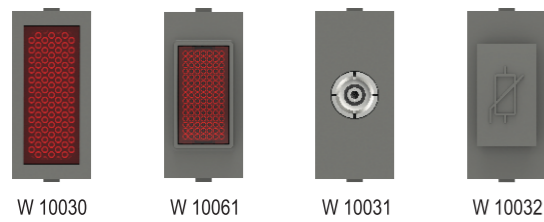

CODE	ITEM	MRP(Rs.)	PURE WHITE	METALLIC CHROME/BLACK	PKG OUTER/MASTER
------	------	----------	------------	-----------------------	------------------

**WOOD-em INDICATOR/TV ANT./KITKAT/USB**

W 10030	Neon Indicator	69.00	83.00	20 / 1200
W 10061	Divine Indicator	69.00	83.00	20 / 1200
W 10031	Mini TV Antenna (with cord-grip configuration)	86.00	98.00	20 / 1200
W 10032	Kitkat Fuse (suitable for 10 Amp. & 16 Amp.)	98.00	111.00	20 / 1200
W 10052	USB Charger (single USB Type-A) (9W)	590.00	602.00	10 / 600
W 10070	USB Charger with Indicator 2 Port C-Type & A-Type (Fast Charging) Input 240V~ 50-60Hz Output-18W 3.1A	1122.00	1135.00	10 / 600
W 10071	USB Charger with Indicator 1 Port C-Type (Fast Charging) Input 240V~ 50-60Hz Output-20W 3.1A	917.00	930.00	10 / 600

**WOOD-em TEL. JACK / COMP. JACK / BLANK PLATE**

W 10033	Telephone Jack - Single with Shutter	93.00	106.00	20 / 1200
W 10034	Telephone Jack - Double without Shutter	124.00	138.00	20 / 1200
W 10035	Computer Jack with Shutter	150.00	170.00	10 / 450
W 10037	Blank Plate - Single	19.00	22.00	50 / 3000
W 10074*	Telephone Jack - RJ 11 (New)	93.00	106.00	20 / 1200
W 10075*	EDP Socket Outlet - RJ 45 (6e) (New) Universal wiring T568a, Insulating-piercing terminal	477.00	506.00	20 / 1200

**WOOD-em HOTEL & HOSPITALITY RANGE**

W 10063	Nova 32 Amp. D.P. Main Switch with Key Ring Tag	477.00	513.00	10 / 200
W 10064	Nova Key Ring Tag Only	108.00	123.00	200 / 4000

**WOOD-em BUZZER / NIGHT LAMP / MINI LED FOOT LIGHT**

W 10040	Electric Buzzer	266.00	285.00	10 / 450
W 10041	LED Moon Night Lamp □ Cool White	258.00	278.00	10 / 450
W 10042	2M Mini LED Foot Light ■ Red ■ Blue □ Warm White □ Cool White	258.00	278.00	10 / 450
W 10042A	3M LED Foot Light □ Cool White	387.00	413.00	10 / 300

\* NEWLY INTRODUCED

CODE	ITEM	MRP(Rs.)	PURE WHITE	METALLIC CHROME/BLACK	PKG OUTER/MASTER
------	------	----------	------------	-----------------------	------------------

**WOOD-em LED FOOT LIGHT**

W 10073*	LUMO 3M Foot Light (New) with 6 LEDs ■ Blue □ Warm White □ Cool White	280.00	302.00	05 / 120
----------	--	--------	--------	----------

**WOOD-em FOOT LIGHT / LED FOOT LIGHT**

W 10043	UNO 4M Foot Light with 18 LEDs	490.00	515.00	05 / 120
W 10044	SIRIO 4M Foot Light Diffused with 18 LEDs	490.00	515.00	05 / 120
W 10065	PRISCA 4M Foot Light Diffused with 8 LEDs	441.00	467.00	05 / 120
W 10069	LARIO 4M Foot Light Diffused with 8 LEDs ■ Red ■ Blue □ Warm White □ Cool White	441.00	467.00	05 / 120

**WOOD-em OPEL M.C.B.**

W 10045	OPEL Single Pole M.C.B. (6 Amp. to 32 Amp.)	215.00	226.00	10 / 600
W 10046	OPEL Double Pole M.C.B. (6 Amp. to 32 Amp.)	467.00	490.00	10 / 300

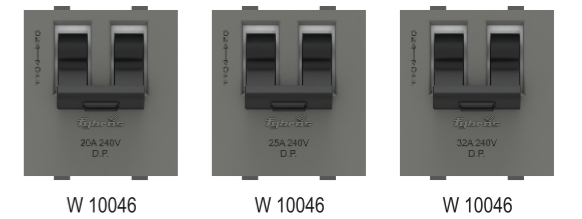
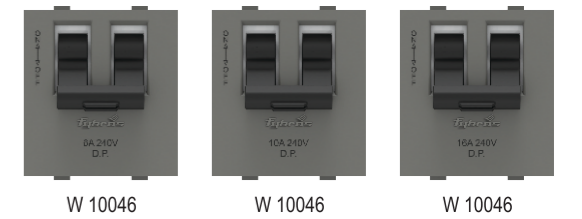
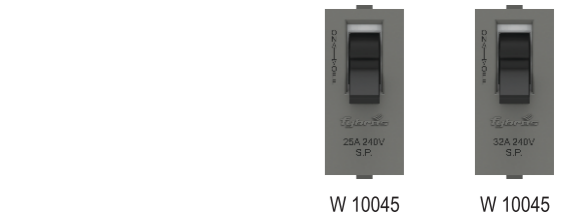
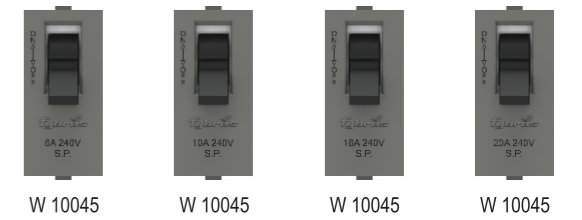
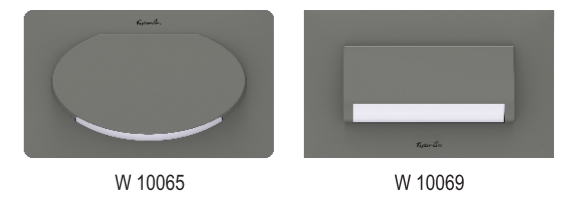
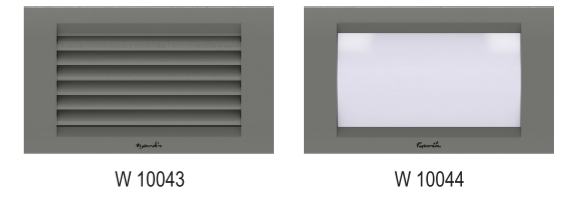

\* NEWLY INTRODUCED

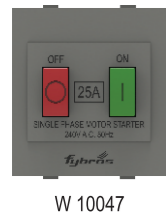
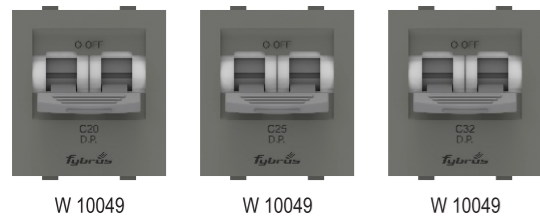
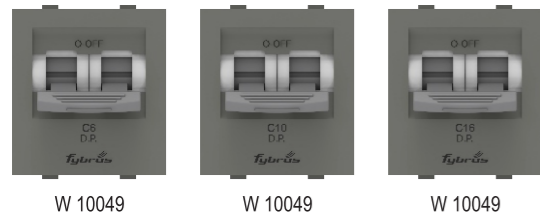

CODE	ITEM	MRP(Rs.)	PURE WHITE	METALLIC CHROME/BLACK	PKG OUTER / MASTER
<b>WOOD-em IKON M.C.B.</b>					
W 10048	IKON Single Pole M.C.B. (6 Amp. to 32 Amp.)	235.00	245.00	10 / 600	
W 10049	IKON Double Pole M.C.B. (6 Amp. to 32 Amp.)	475.00	495.00	10 / 300	
<b>WOOD-em MOTOR STARTER</b>					
W 10047	25 Amp. Single Phase Motor Starter	468.00	493.00	10 / 300	
<b>WOOD-em WAVE PLUS</b>					
W 10101	Wave Plus Modular Plug, Socket Enclosure & Mini MCB ( with Metal box)	996.00	-	01 / 300	



W 30071



W 30072



W 30073



W 30074



W 30075



W 30076

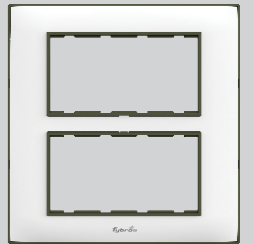

W 30077

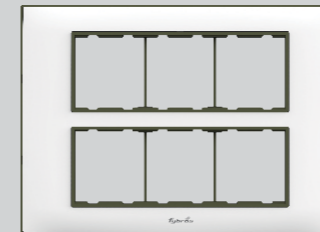

W 30078



W 30079

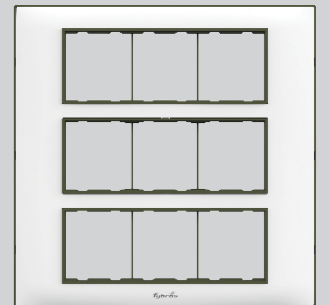

W 30080

**AXEL MODULAR PLATES WITH MOUNTING FRAMES - SUITABLE FOR METAL BOX**

MODULES	1M	2M	3M	4M	6M	8M - H	8M - V	12M	16M	18M
PLATES	MRP ₹	MRP ₹	MRP ₹	MRP ₹	MRP ₹	MRP ₹	MRP ₹	MRP ₹	MRP ₹	MRP ₹
BASIC	₹ 69/-	₹ 69/-	₹ 84/-	₹ 100/-	₹ 143/-	₹ 180/-	₹ 180/-	₹ 219/-	₹ 239/-	₹ 268/-
CODE	W 30071	W 30072	W 30073	W 30074	W 30075	W 30076	W 30077	W 30078	W 30079	W 30080
PKG.	10/600	10/600	10/600	10/450	10/300	10/300	10/270	10/240	10/200	10/160
SIZE (mm)	90 X 90	90 X 90	90 X 118	90 X 152	90 X 220	90 X 260	157 X 152	158 X 220	157 X 260	220 X 220

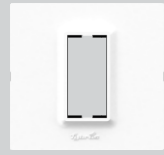

W 70001

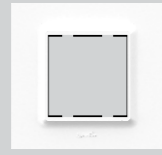

W 70002

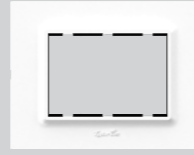

W 70003

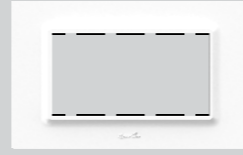

W 70004

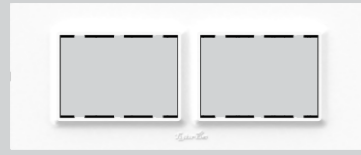

W 70005

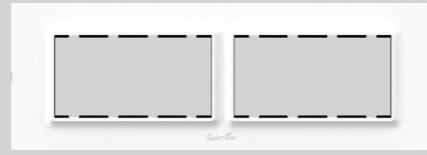

W 70006

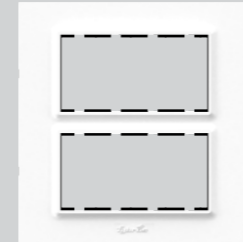

W 70007

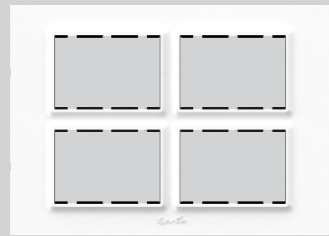

W 70008

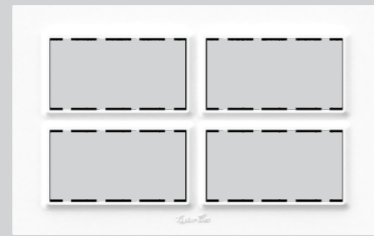

W 70010

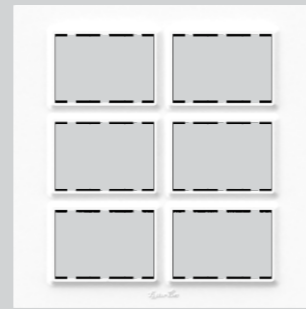

W 70009

**ARROW MODULAR PLATES WITH MOUNTING FRAMES - SUITABLE FOR METAL BOX**

MODULES	1M	2M	3M	4M	6M	8M - H	8M - V	12M	16M	18M
PLATES	MRP ₹	MRP ₹	MRP ₹	MRP ₹	MRP ₹	MRP ₹	MRP ₹	MRP ₹	MRP ₹	MRP ₹
BASIC	₹ 69/-	₹ 69/-	₹ 84/-	₹ 100/-	₹ 143/-	₹ 180/-	₹ 180/-	₹ 219/-	₹ 239/-	₹ 268/-
BASIC PREMIUM	₹ 78/-	₹ 78/-	₹ 93/-	₹ 105/-	₹ 155/-	₹ 189/-	₹ 189/-	₹ 255/-	₹ 288/-	₹ 292/-
METALLIC	₹ 125/-	₹ 125/-	₹ 165/-	₹ 181/-	₹ 248/-	₹ 334/-	₹ 334/-	₹ 414/-	₹ 473/-	₹ 484/-
WOOD	₹ 136/-	₹ 136/-	₹ 181/-	₹ 209/-	₹ 271/-	₹ 370/-	₹ 370/-	₹ 506/-	₹ 539/-	₹ 564/-
CODE	W 70001	W 70002	W 70003	W 70004	W 70005	W 70006	W 70007	W 70008	W 70010	W 70009
PKG.	10/600	10/600	10/600	10/450	10/300	10/300	10/270	10/240	10/200	10/160
SIZE (mm)	90 X 94	90 X 94	90 X 118	90 X 146	90 X 220	90 X 260	158 X 152	158 X 220	158 X 260	220 X 220



W 50001

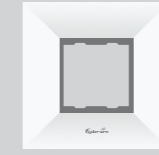

W 50002

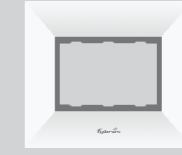

W 50003

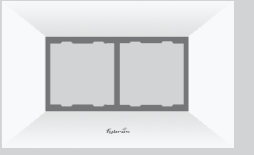

W 50004



W 50005



W 50011



W 50006

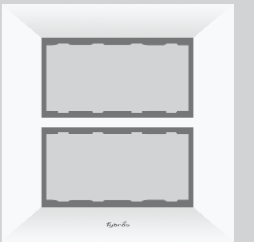

W 50007

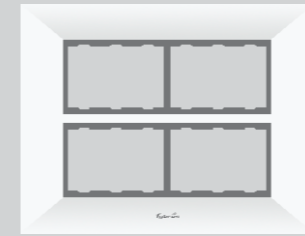

W 50008

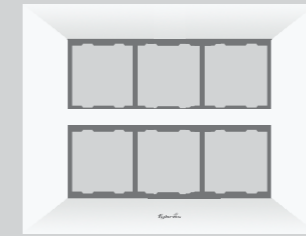

W 50012

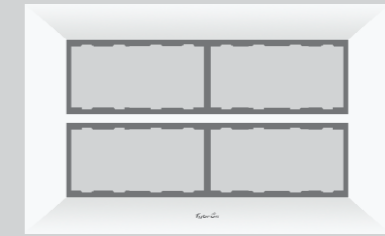

W 50010

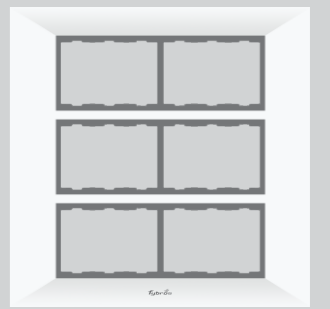

W 50009

**AIR MODULAR PLATES WITH MOUNTING FRAMES - SUITABLE FOR METAL BOX**

MODULES	1M	2M	3M	4M	6M	6M-P	8M - H	8M - V	12M	12M-P	16M	18M
PLATES	MRP ₹	MRP ₹	MRP ₹	MRP ₹	MRP ₹	MRP ₹	MRP ₹	MRP ₹	MRP ₹	MRP ₹	MRP ₹	MRP ₹
BASIC	₹ 69/-	₹ 69/-	₹ 84/-	₹ 100/-	₹ 143/-	₹ 143/-	₹ 180/-	₹ 180/-	₹ 219/-	₹ 219/-	₹ 239/-	₹ 268/-
METALLIC	₹ 125/-	₹ 125/-	₹ 165/-	₹ 181/-	₹ 248/-	₹ 248/-	₹ 334/-	₹ 334/-	₹ 414/-	₹ 414/-	₹ 473/-	₹ 484/-
WOOD	₹ 136/-	₹ 136/-	₹ 181/-	₹ 209/-	₹ 271/-	₹ 271/-	₹ 370/-	₹ 370/-	₹ 506/-	₹ 506/-	₹ 539/-	₹ 564/-
CODE	W 50001	W 50002	W 50003	W 50004	W 50005	W 50011	W 50006	W 50007	W 50008	W 50012	W 50010	W 50009
PKG.	10/600	10/600	10/600	10/450	10/300	10/300	10/300	10/270	10/240	10/240	10/200	10/160
SIZE (mm)	90 X 94	90 X 94	90 X 118	90 X 146	90 X 220	90 X 220	93 X 260	158 X 152	158 X 220	158 X 220	158 X 260	220 X 220



W 30051



W 30052



W 30053



W 30054

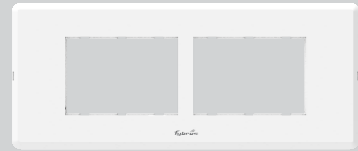

W 30055

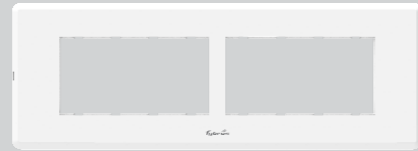

W 30056



W 30057

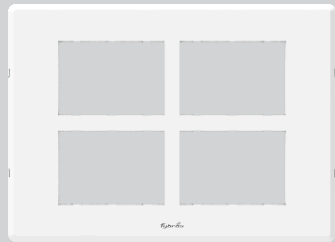

W 30058

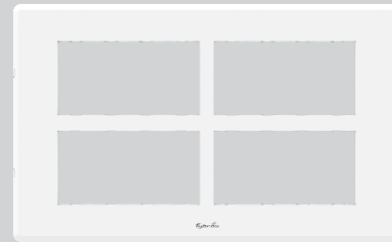

W 30060



W 30059

**ASTRA MODULAR PLATES WITH MOUNTING FRAMES - SUITABLE FOR METAL BOX**

MODULES	1M	2M	3M	4M	6M	8M - H	8M - V	12M	16M	18M
PLATES	MRP ₹	MRP ₹	MRP ₹	MRP ₹	MRP ₹	MRP ₹	MRP ₹	MRP ₹	MRP ₹	MRP ₹
BASIC	₹ 69/-	₹ 69/-	₹ 84/-	₹ 100/-	₹ 143/-	₹ 180/-	₹ 180/-	₹ 219/-	₹ 239/-	₹ 268/-
CODE	W 30051	W 30052	W 30053	W 30054	W 30055	W 30056	W 30057	W 30058	W 30060	W 30059
PKG.	10/600	10/600	10/600	10/450	10/300	10/300	10/270	10/240	10/200	10/160
SIZE (mm)	95 X 98	95 X 98	95 X 123	95 X 150	95 X 225	95 X 265	163 X 156	163 X 225	163 X 265	225 X 225



W 70051

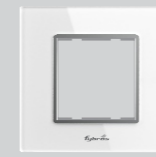

W 70052

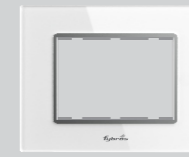

W 70053



W 70054



W 70055

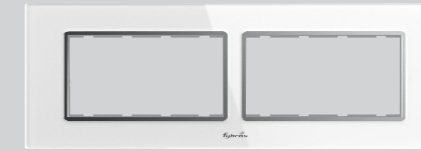

W 70056

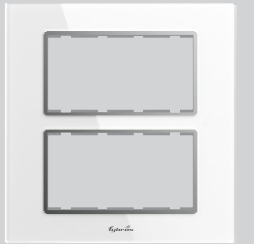

W 70057

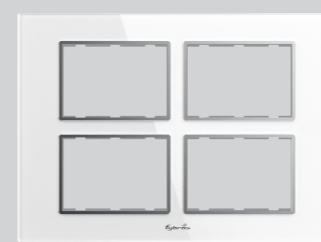

W 70058

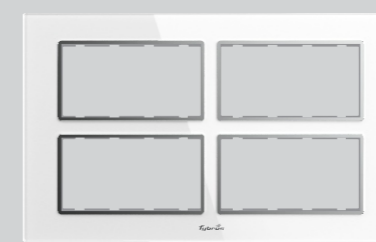

W 70059



W 70060

**ALPHA ACRYLIC MODULAR PLATES WITH MOUNTING FRAMES - SUITABLE FOR METAL BOX**

MODULES	1M	2M	3M	4M	6M	8M - H	8M - V	12M	16M	18M
PLATES	MRP ₹	MRP ₹	MRP ₹	MRP ₹	MRP ₹	MRP ₹	MRP ₹	MRP ₹	MRP ₹	MRP ₹
ACRYLIC	₹ 248/-	₹ 248/-	₹ 317/-	₹ 365/-	₹ 482/-	₹ 577/-	₹ 577/-	₹ 718/-	₹ 812/-	₹ 906/-
CODE	W 70051	W 70052	W 70053	W 70054	W 70055	W 70056	W 70057	W 70058	W 70059	W 70060
PKG.	10/180	10/180	10/180	10/180	05/90	05/90	05/90	05/60	05/40	05/40
SIZE (mm)	90 X 94	90 X 94	90 X 118	90 X 146	90 X 220	90 X 260	158 X 152	158 X 220	158 X 260	220 X 220

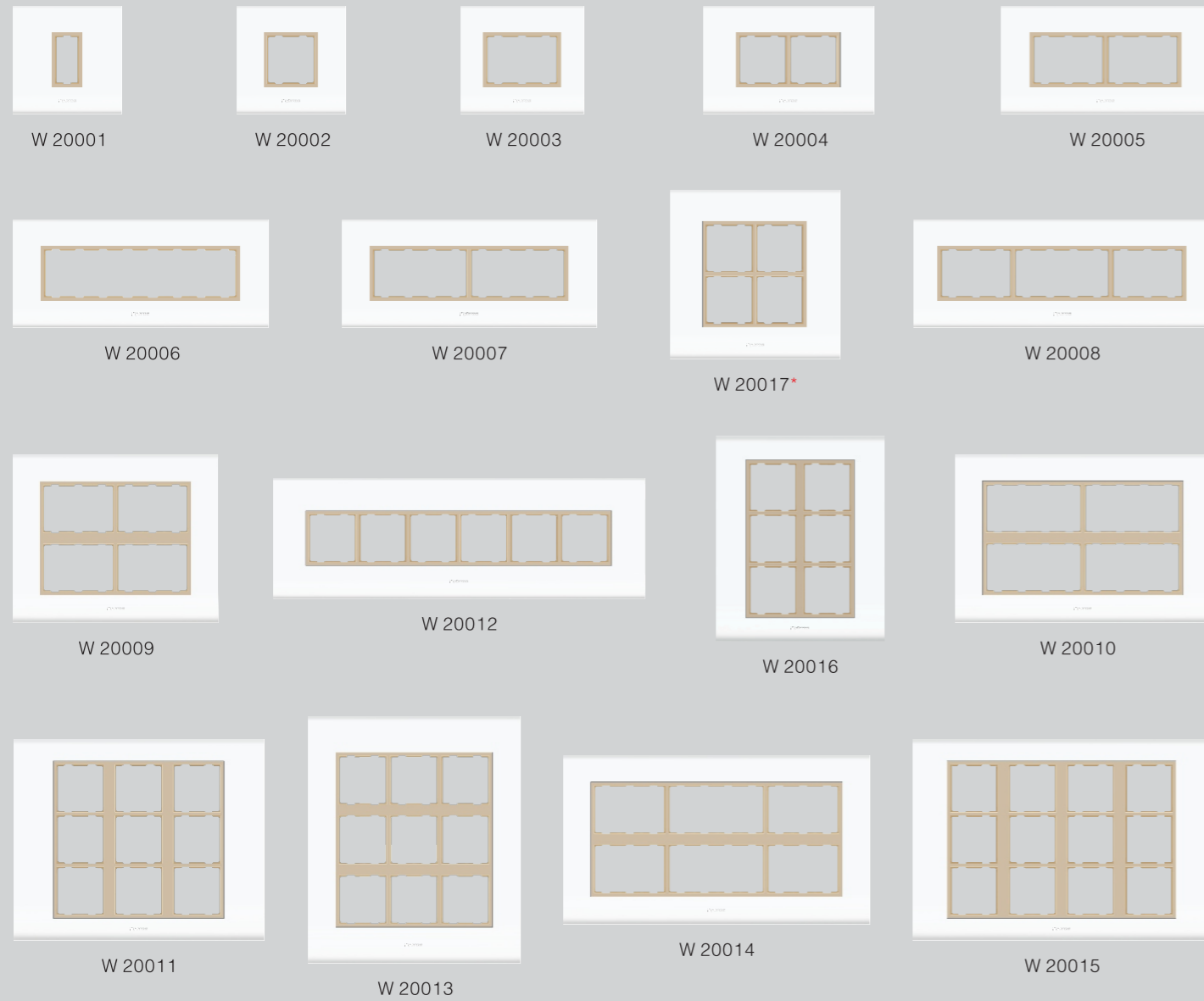

**AXCENT WOODEN MODULAR PLATES WITH MOUNTING FRAMES - SUITABLE FOR WOODEN BOX**

MODULES	1M	2M	3M	4M	6M	8M-W/P	8M-H	8M-V	10M	12M-V	12M-H	12M-P	16M	18M-H	18M-V	20M	24M
COLOUR	MRP ₹	MRP ₹	MRP ₹	MRP ₹	MRP ₹	MRP ₹	MRP ₹	MRP ₹	MRP ₹	MRP ₹	MRP ₹	MRP ₹	MRP ₹	MRP ₹	MRP ₹	MRP ₹	MRP ₹
BASIC	₹ 84/-	₹ 84/-	₹ 98/-	₹ 127/-	₹ 148/-	₹ 176/-	₹ 176/-	₹ 176/-	₹ 198/-	₹ 213/-	₹ 306/-	₹ 213/-	₹ 243/-	₹ 279/-	₹ 279/-	₹ 331/-	₹ 385/-
BASIC PREMIUM	₹ 96/-	₹ 96/-	₹ 121/-	₹ 149/-	₹ 179/-	₹ 218/-	₹ 218/-	₹ 218/-	₹ 254/-	₹ 283/-	₹ 384/-	₹ 283/-	₹ 313/-	₹ 369/-	₹ 369/-	₹ 434/-	₹ 482/-
METALLIC PREMIUM	₹ 155/-	₹ 155/-	₹ 197/-	₹ 253/-	₹ 306/-	₹ 393/-	₹ 393/-	₹ 393/-	₹ 447/-	₹ 490/-	₹ 590/-	₹ 490/-	₹ 564/-	₹ 613/-	₹ 613/-	₹ 699/-	₹ 760/-
WOOD	₹ 147/-	₹ 147/-	₹ 179/-	₹ 253/-	₹ 276/-	₹ 363/-	₹ 363/-	₹ 363/-	₹ 393/-	₹ 416/-	₹ 579/-	₹ 416/-	₹ 478/-	₹ 577/-	₹ 577/-	₹ 673/-	₹ 740/-
CODE	W 20001	W 20002	W 20003	W 20004	W 20005	W 20006	W 20007	W 20017	W 20008	W 20009	W 20012	W 20016	W 20010	W 20011	W 20013	W 20014	W 20015
PKG.	10/480	10/480	10/360	10/240	10/240	10/240	10/240	10/240	10/200	10/180	10/100	10/180	10/180	10/100	10/100	10/120	10/100
SIZE (inches)	4.5 X 4.5	4.5 X 4.5	4.5 X 5	4.5 X 7	4.5 X 8.5	4.5 X 10.5	4.5 X 10.5	7.0 X 7.0	4.5 X 12.5	7.0 X 8.5	5.0 X 15.5	8.5 X 7	7.0 X 10.5	8.5 X 10.5	10.5 X 9	7.0 X 12.5	8.5 X 12.5

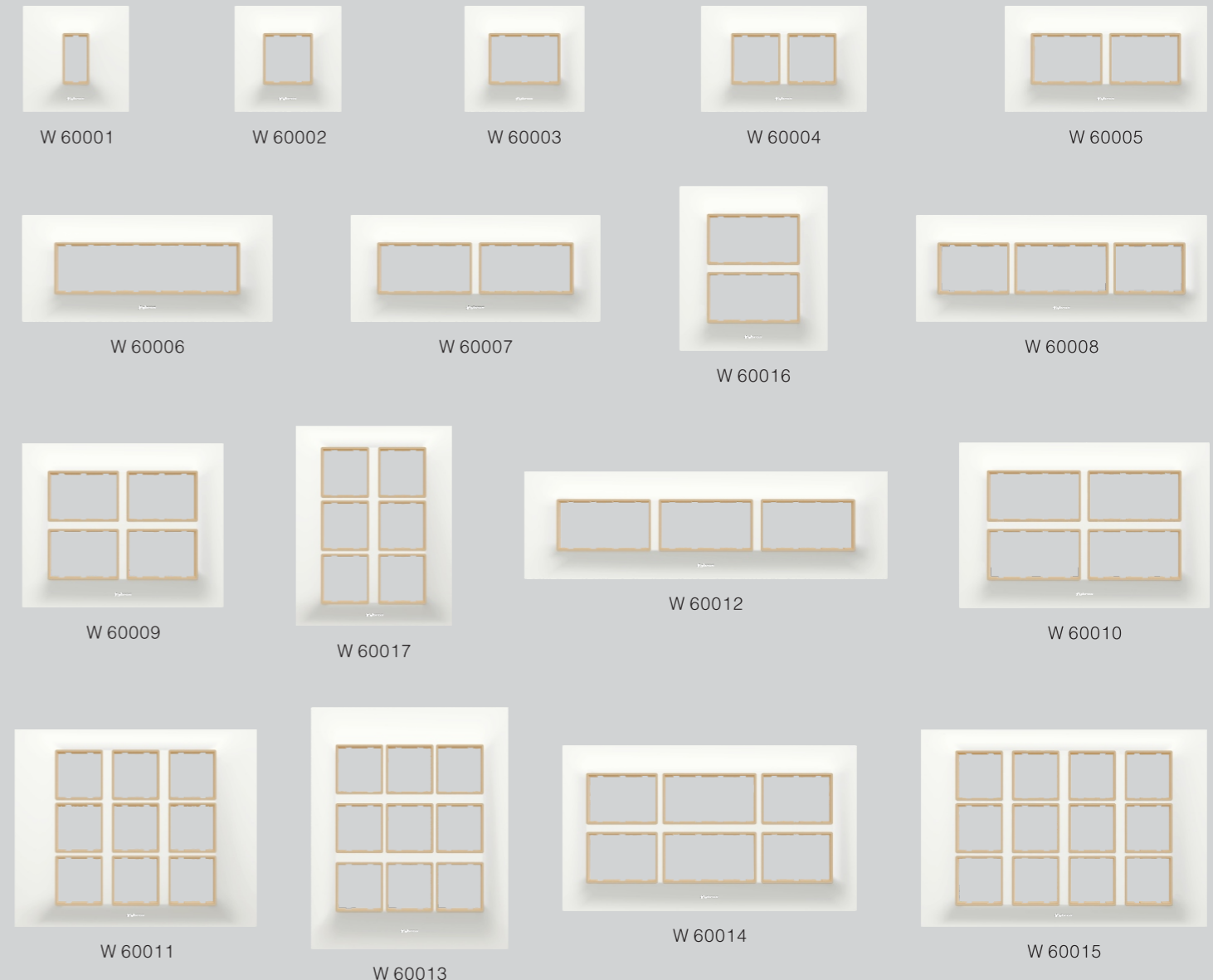

**A-NINE WOODEN MODULAR PLATES WITH MOUNTING FRAMES - SUITABLE FOR WOODEN BOX**

MODULES	1M	2M	3M	4M	6M	8M-W/P	8M-H	8M-V	10M	12M-V	12M-P	12M-H	16M	18M-H	18M-V	20M	24M
Colour	MRP ₹	MRP ₹	MRP ₹	MRP ₹	MRP ₹	MRP ₹	MRP ₹	MRP ₹	MRP ₹	MRP ₹	MRP ₹	MRP ₹	MRP ₹	MRP ₹	MRP ₹	MRP ₹	MRP ₹
BASIC	₹ 84/-	₹ 84/-	₹ 98/-	₹ 127/-	₹ 148/-	₹ 176/-	₹ 176/-	₹ 176/-	₹ 198/-	₹ 213/-	₹ 213/-	₹ 306/-	₹ 243/-	₹ 279/-	₹ 279/-	₹ 331/-	₹ 385/-
BASIC PREMIUM	₹ 96/-	₹ 96/-	₹ 121/-	₹ 149/-	₹ 179/-	₹ 218/-	₹ 218/-	₹ 218/-	₹ 254/-	₹ 283/-	₹ 283/-	₹ 384/-	₹ 313/-	₹ 369/-	₹ 369/-	₹ 434/-	₹ 482/-
METALLIC	₹ 129/-	₹ 129/-	₹ 150/-	₹ 199/-	₹ 232/-	₹ 275/-	₹ 275/-	₹ 275/-	₹ 314/-	₹ 337/-	₹ 337/-	₹ 483/-	₹ 381/-	₹ 436/-	₹ 436/-	₹ 523/-	₹ 607/-
CODE	W 60001	W 60002	W 60003	W 60004	W 60005	W 60006	W 60007	W 60016	W 60008	W 60009	W 60017	W 60012	W 60010	W 60011	W 60013	W 60014	W 60015
PKG.	10/480	10/480	10/360	10/240	10/240	10/240	10/240	10/240	10/200	10/180	10/180	10/100	10/180	10/100	10/100	10/120	10/100
SIZE (inches)	4.5 X 4.5	4.5 X 4.5	4.5 X 5	4.5 X 7	4.5 X 8.5	4.5 X 10.5	4.5 X 10.5	7.0 X 7.0	4.5 X 12.5	7.0 X 8.5	9.0 X 7.0	4.5 X 15.5	7.0 X 10.5	8.5 X 10.5	10.5 X 8.5	7.0 X 12.5	8.5 X 12.5

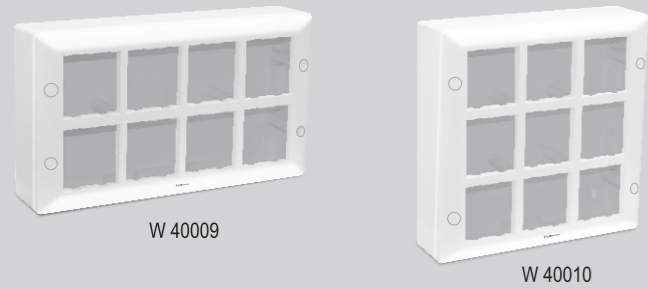
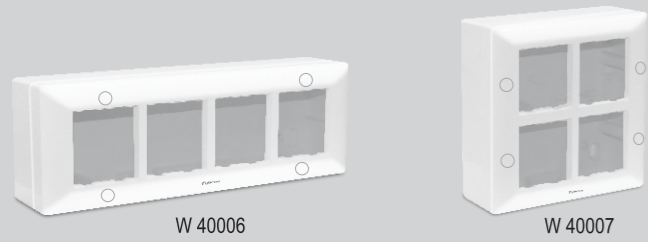

CODE	ITEM	MRP(Rs.)	PKG OUTER / MASTER
<b>WOOD-em SWING MODULAR SURFACE GANG BOX</b>			
W 40001	1M. Swing Surface Gang Box	75.00	20 / 360
W 40002	2M. Swing Surface Gang Box	87.00	10 / 180
W 40003	3M. Swing Surface Gang Box	99.00	10 / 180
W 40004	4M. Swing Surface Gang Box	119.00	10 / 180
W 40005	6M. Swing Surface Gang Box	139.00	10 / 120
W 40006	8M - H Swing Surface Gang Box	169.00	10 / 120
W 40007	8M - V Swing Surface Gang Box	169.00	05 / 90
W 40011	9M. Swing Surface Gang Box	191.00	10 / 120
W 40008	12M. Swing Surface Gang Box	223.00	05 / 90
W 40009	16M. Swing Surface Gang Box	290.00	05 / 60
W 40010	18M. Swing Surface Gang Box	294.00	05 / 60

**WOOD-em SWING MODULAR SURFACE GANG BOX**

CODE	ITEM	MRP(Rs.)	PKG OUTER / MASTER
<b>WOOD-em OVAL MODULAR SURFACE GANG BOX</b>			
W 40051	1M. Oval Surface Gang Box	75.00	20 / 360
W 40052	2M. Oval Surface Gang Box	87.00	10 / 180
W 40053	3M. Oval Surface Gang Box	99.00	10 / 180
W 40054	4M. Oval Surface Gang Box	119.00	10 / 180
W 40055	6M. Oval Surface Gang Box	139.00	10 / 120
W 40056	8M - H Oval Surface Gang Box	169.00	10 / 120
W 40057	8M - V Oval Surface Gang Box	169.00	05 / 90
W 40061	9M. Oval Surface Gang Box	191.00	10 / 120
W 40058	12M. Oval Surface Gang Box	223.00	05 / 90
W 40059	16M. Oval Surface Gang Box	290.00	05 / 60
W 40060	18M. Oval Surface Gang Box	294.00	05 / 60

**WOOD-em OVAL MODULAR SURFACE GANG BOX**



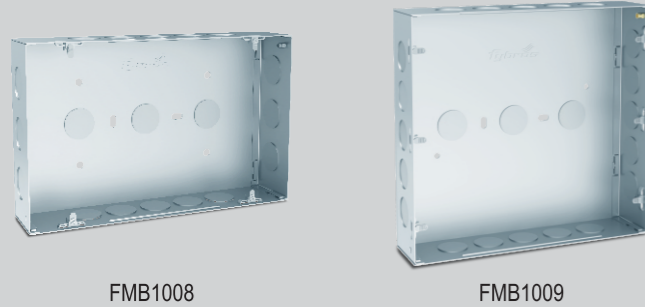
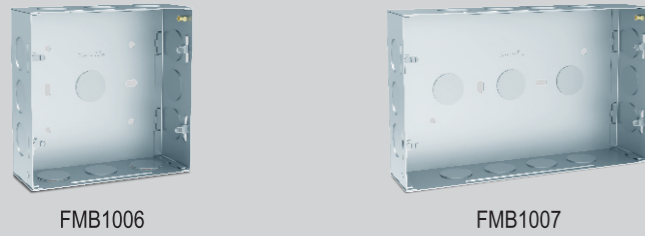
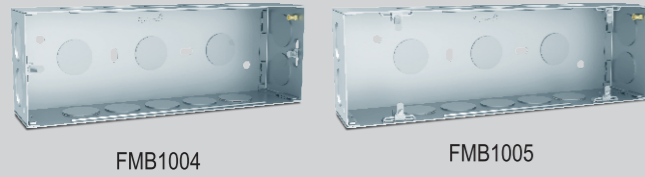

CODE	ITEM	MRP(Rs.)	PKG OUTER / MASTER
<b>WOOD-em REMOVE METAL GANG BOX</b> <span style="background-color: red; color: white; padding: 2px;">NEW</span>			
FMB1001	1 & 2M. Remove Metal Gang Box	77.00	20 / 120
FMB1002	3M. Remove Metal Gang Box	94.00	20 / 120
FMB1003	4M. Remove Metal Gang Box	106.00	20 / 120
FMB1004	6M. Remove Metal Gang Box	153.00	10 / 80
FMB1005	8M - H Remove Metal Gang Box	188.00	10 / 80
FMB1006	8M - V Remove Metal Gang Box	188.00	05 / 60
FMB1007	12M. Remove Metal Gang Box	237.00	05 / 40
FMB1008	16M. Remove Metal Gang Box	294.00	05 / 40
FMB1009	18M. Remove Metal Gang Box	335.00	05 / 40

NEWLY INTRODUCED

**BASIC**

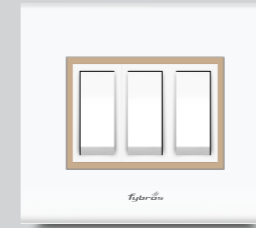

Basic Ivory

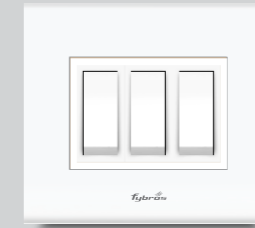

Basic White

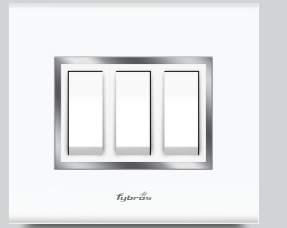

Basic Premium

**METALLIC**  
premium

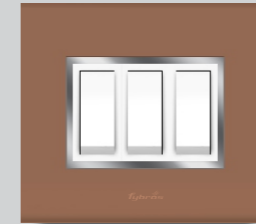

Chocolate Brown

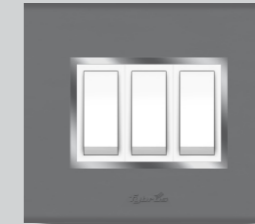

Metallic Chrome Premium

**WOOD**

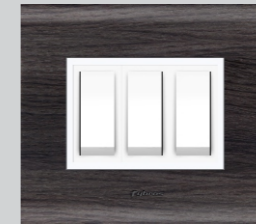

African Wenge



Italian Walnut



Cherry Wood

**A-NINE**  
MODULAR PLATES

**BASIC**

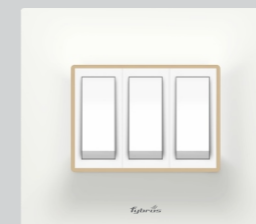

Basic Ivory

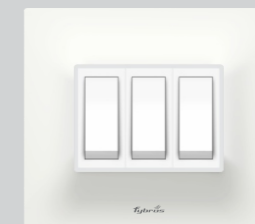

Basic White

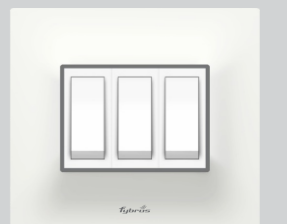

Basic Green

**BASIC**  
premium



Basic Premium

**METALLIC**

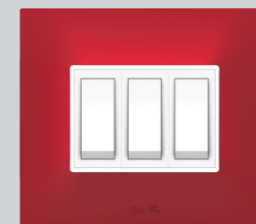

Cherry Red



Aqua Green

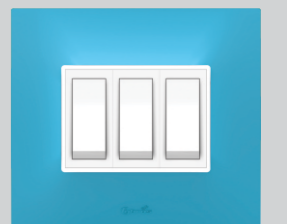

Aqua Blue

**BASIC**

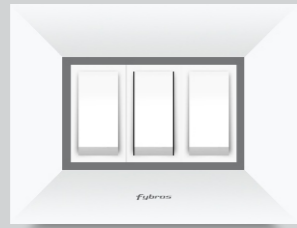

Basic Green

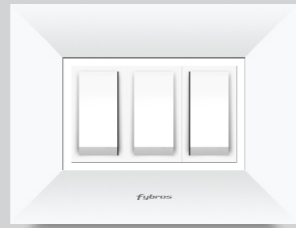

Basic White

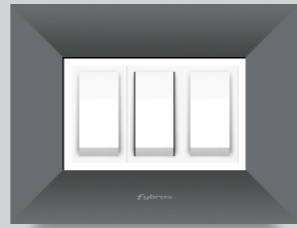

Basic Grey

**METALLIC**

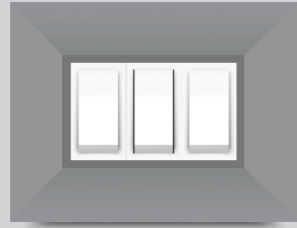

Platinum Chrome

**WOOD**



African Wenge



Italian Walnut

**ASTRA**  
MODULAR PLATES

**BASIC**

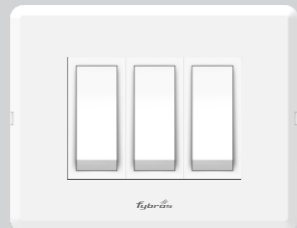

Basic White

**AXEL** NEW  
MODULAR PLATES

**BASIC**

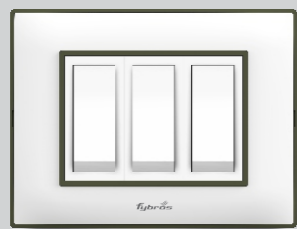

Basic Green

NEWLY INTRODUCED

**BASIC**

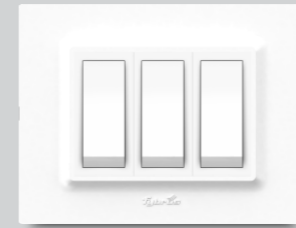

Basic White

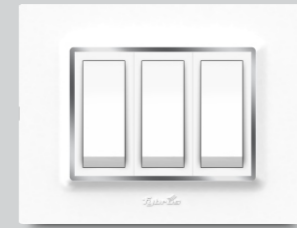

Basic Premium

**BASIC**  
premium

**METALLIC**

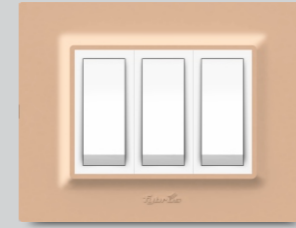

Mystic Copper

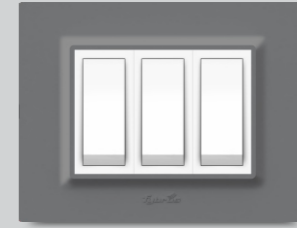

Mystic Chrome

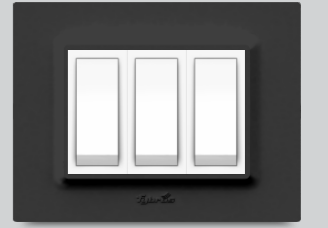

Matty Black

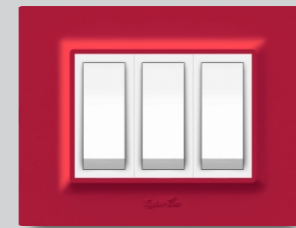

Cherry Red

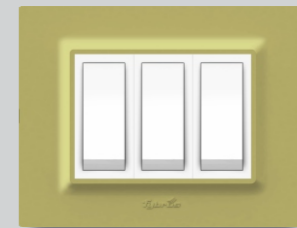

Aqua Green

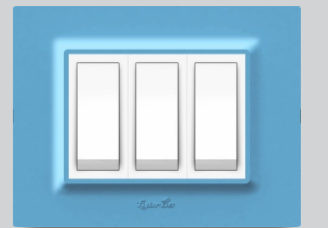

Aqua Blue

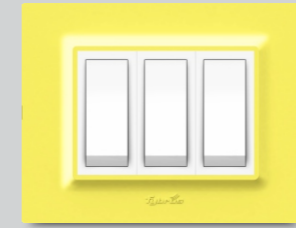

Majestic Yellow

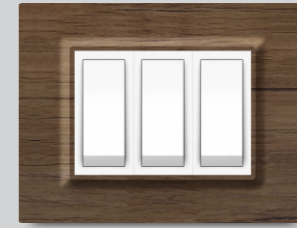

Italian Walnut

**WOOD**

**ALPHA**  
ACRYLIC PLATES

**BASIC**

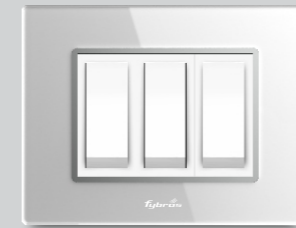

Polar White



Thunder Chrome

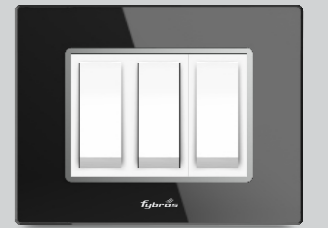

Space Black

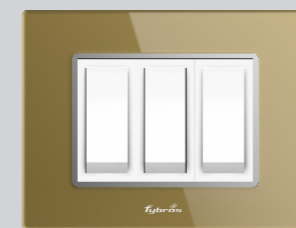

Warm Tan

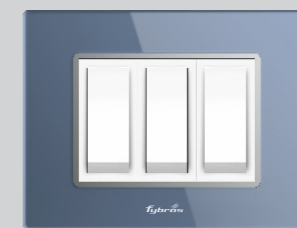

Galaxy Blue

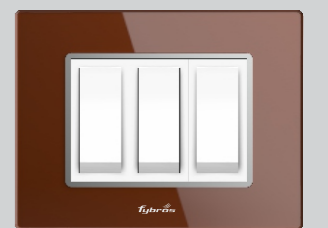

Deep Maroon

Note: Colours shown may not match actual product colours due to printing limitations.

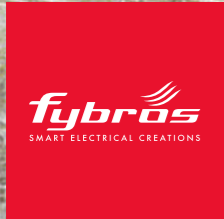

ZINE  
SERIES

# GLOW

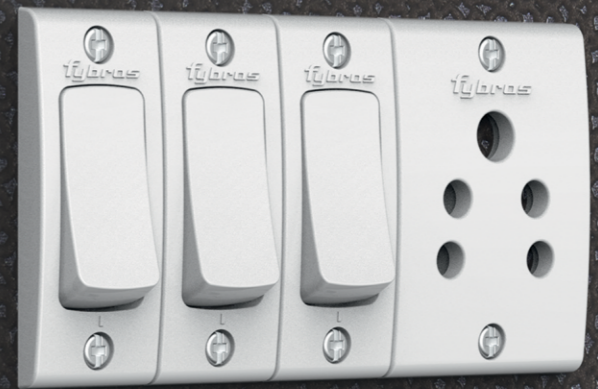

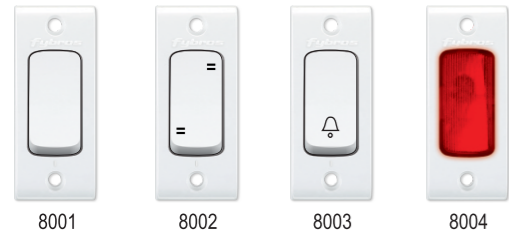

CODE	ITEM	MRP(Rs.)	PKG OUTER / MASTER
<b>ZINE 6 AMP. GLOW SWITCHES / INDICATOR</b>			
8001	1 Way Switch	30.00	20 / 1200
8002	2 Way Switch	37.00	20 / 1200
8003	Bell Push	37.00	20 / 1200
8004	Indicator	37.00	20 / 1200

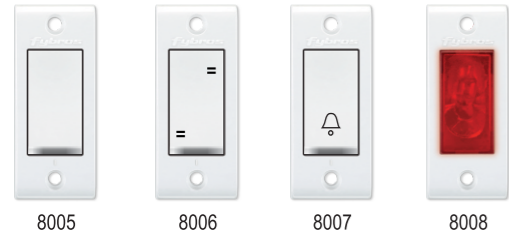

CODE	ITEM	MRP(Rs.)	PKG OUTER / MASTER
<b>ZINE 6 AMP. BLOOM SWITCHES / INDICATOR</b>			
8005	1 Way Switch	30.00	20 / 1200
8006	2 Way Switch	36.00	20 / 1200
8007	Bell Push	36.00	20 / 1200
8008	Indicator	36.00	20 / 1200

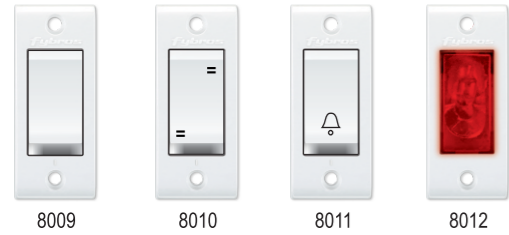

CODE	ITEM	MRP(Rs.)	PKG OUTER / MASTER
<b>ZINE 6 AMP. SHINE SWITCHES / INDICATOR</b>			
8009	1 Way Switch	30.00	20 / 1200
8010	2 Way Switch	36.00	20 / 1200
8011	Bell Push	36.00	20 / 1200
8012	Indicator	36.00	20 / 1200



CODE	ITEM	MRP(Rs.)	PKG OUTER / MASTER
<b>ZINE 6 AMP. SOCKETS / INTERNATIONAL SOCKET</b>			
8021	2 Pin Socket	36.00	20 / 1200
8022	2 In 1 Socket	43.00	10 / 600
8024	13 Amp. international Socket	86.00	10 / 300
8025	6 Amp. 3 Pin Socket	43.00	10 / 600



CODE	ITEM	MRP(Rs.)	PKG OUTER / MASTER
<b>ZINE TV ANTENA / TEL. JACK / KIT-KAT FUSE / USB</b>			
8031	Mini TV Socket	50.00	20 / 1200
8032	Mini 2 Line Tel. Jack with enclosure	83.00	20 / 1200
8033	10A Kit-Kat Fuse	51.00	20 / 600
8034	16A Kit-Kat Fuse	65.00	10 / 300
8035	USB Charger indicator (with single USB Port) 2Amp. 240~A.C. Only	560.00	10 / 450

CODE	ITEM	MRP(Rs.)	PKG OUTER / MASTER
<b>ZINE DIMMER / REGULATOR</b>			
8041	Mini Dimmer	212.00	10 / 450
8042	Medium Dimmer	219.00	10 / 300
8043	4 Step Regulator	291.00	10 / 450
8044	5 Step Regulator	334.00	10 / 300



CODE	ITEM	MRP(Rs.)	PKG OUTER / MASTER
<b>ZINE 6A S.S. COMBINED WITH JUNCTION BOX</b>			
8051A	6A 3 Pin S.S. Combined indicator	97.00	05 / 200
8052A	6A 3 Pin S.S. Combined indicator & J. Box	110.00	05 / 200



CODE	ITEM	MRP(Rs.)	PKG OUTER / MASTER
<b>ZINE 16AMP. SWITCH &amp; SOCKET</b>			
8053	16A 1 Way Switch	120.00	10 / 200
8053A	16A 1 Way Switch (Dolly)	120.00	10 / 200
8054	16A 2 Way Switch	147.00	10 / 200
8054A	16A 2 Way Switch (Dolly)	147.00	10 / 200
8055	6 & 16A Universal Socket safety shutter	120.00	10 / 200
8055A	6 & 16A Universal Socket	120.00	10 / 200

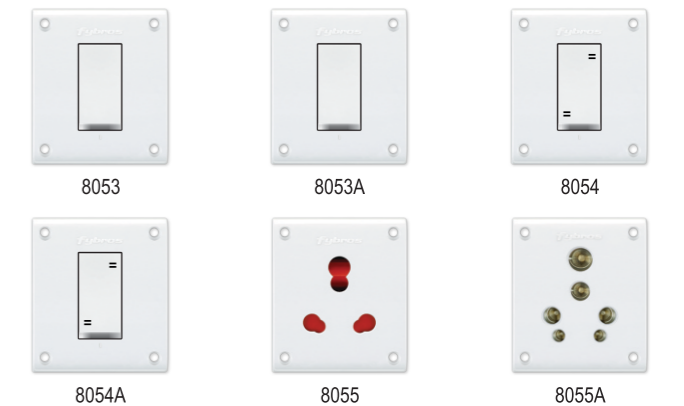

CODE	ITEM	MRP(Rs.)	PKG OUTER / MASTER
<b>ZINE 16AMP. 3 IN ONE WITH JUNCTION BOX</b>			
8056	3 In 1 Uni. S.S. Comb. safety shutter	206.00	05 / 100
8056A	3 In 1 Uni. S.S. Comb. (Dolly)	206.00	05 / 100
8057	3 In 1 Uni. S.S. Combined J. Box safety shutter	224.00	05 / 100
8057A	3 In 1 Uni. S.S. Combined J. Box (Dolly)	224.00	05 / 100

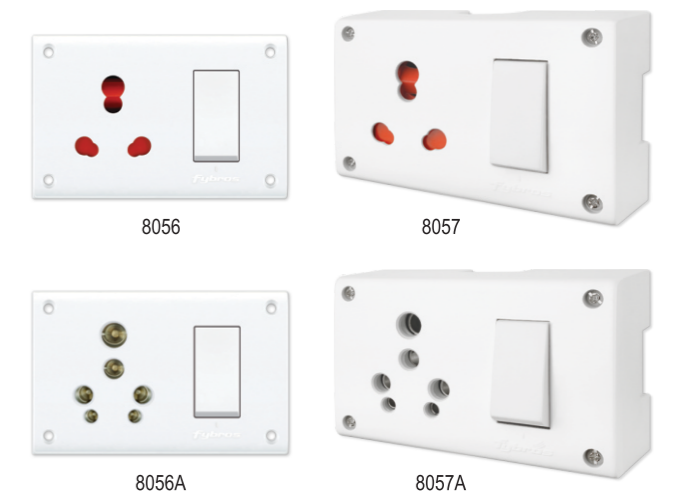

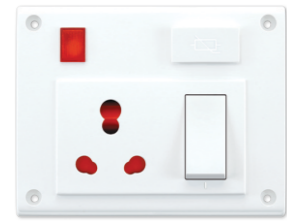

8058



8059



8058A



8059A



8060



8061

CODE	ITEM	MRP(Rs.)	PKG OUTER / MASTER
<b>ZINE 16AMP. 5 IN ONE WITH JUNCTION BOX</b>			
8058	5 In 1 Uni. S.S. Combined fuse, indicator & safety shutter	282.00	05 / 80
8058A	5 In 1 Uni. S.S. Combined (Dolly) fuse, indicator	282.00	05 / 80
8059	5 In 1 Uni. S.S. Combined J. Box fuse, indicator & safety shutter	320.00	05 / 80
8059A	5 In 1 Uni. S.S. Combined J. Box (Dolly) fuse, indicator	320.00	05 / 80
<b>ZINE 32A DP SWITCH (UNBREAKABLE)</b>			
8060	Surface DP Switch with indicator	224.00	05 / 100
8061	Flush DP Switch with indicator	224.00	05 / 100

ZINE PLUS SERIES





8062 8063 8064 8066



8067

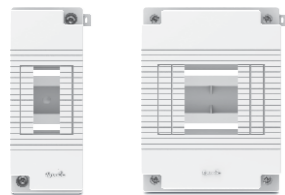

8069 8070



8071 8072 8073



8074



8084 8085 8089 8090



8111 8112 8113

● PACKING CHANGE

CODE	ITEM	MRP(Rs.)	PKG OUTER / MASTER
<b>ZINE PLUS SKIRT LAMP HOLDER</b>			
8062	Angle Holder	33.00	20 / 400
8063	Batten Holder	33.00	20 / 400
8064*	Pendent Holder	33.00	30 / 900
8066	Adaptor	32.00	30 / 1200
8067	Bed Switch	41.00	20 / 1200

**ZINE PLUS ENCLOSURE BOX (UNBREAKABLE)**

8069	1-2 MCB Enclosure (Plastic)	73.00	10 / 200
8070	3-4 MCB Enclosure (Plastic)	104.00	05 / 100

**ZINE PLUS CEILING ROSE**

8071	Pilot Ceiling Rose	35.00	30 / 600
8072	Pilot Ceiling Rose (3 parts)	36.00	30 / 600
8073	Jumbo Ceiling Rose	37.00	20 / 400
8074	Jumbo Ceiling Rose (3 parts)	43.00	20 / 400

**ZINE PLUS PLUG TOP**

8084*	2 Pin Plug / Glade	28.00	50 / 1200
8085	2 Pin Male - Female / Glade	42.00	50 / 1200
8089*	2 Pin Plug / Adora	28.00	50 / 1200
8090	2 Pin Male - Female / Adora	42.00	50 / 1200
8111*	2 Pin Plug / Melon	24.00	50 / 1200
8112*	2 Pin Male - Female / Melon	40.00	50 / 1200
8113*	2 Pin Female / Melon	24.00	100 / 2400

CODE	ITEM	MRP(Rs.)	PKG OUTER / MASTER
<b>ZINE PLUS PLUG TOP</b>			

8081	Elace 6A 3 Pin Top (Unbreakable)	72.00	20 / 600
8082*	Elace 16A 3 Pin Top (Unbreakable)	98.00	10 / 300
V 3011	Elegant 6A 3 Pin Top (Unbreakable)	77.00	20 / 600
V 3012*	Elegant 16A 3 Pin Top (Unbreakable)	98.00	10 / 300
8114	Krysta 6A 3 Pin Top (Unbreakable) with indicator	93.00	20 / 600
8115*	Krysta 16A 3 Pin Top (Unbreakable) with indicator	115.00	10 / 300
8088*	16A 3 Pin Top Heavy Duty with indicator (Unbreakable)	127.00	10 / 300
8118	NEO 6A 3 Pin Top (Urea)	80.00	20 / 600
8119*	NEO 16A 3 Pin Top (Urea)	112.00	10 / 300
8087	Rotor Holder (Pair)	29.00	24 / 720



8081 8082 V3011 V3012



8114 8115 8088



8118 8119 8087

**ZINE PLUS TRAVEL ADAPTOR**

V 3021	Oreo 3 Pin Travel Universal Multi Plug with surge protector & indicator	174.00	10 / 300
8099	Eco 3 Pin Travel Universal Multi Plug with indicator	143.00	10 / 300
8080	Maxx 3 Pin Travel Universal Adaptor	120.00	20 / 600
8117	Xylo 16A 3 Pin Multi Plug Adaptor	220.00	10 / 200
8097	Sliq 3 Pin Travel Universal Multi Plug with indicator	158.00	10 / 300
8086A	3 Pin Multi Plug Adaptor	83.00	20 / 600
8083	3 Pin Travel Universal Adaptor	110.00	20 / 600
8098	Atlas 3 Pin Universal Travel Adaptor with USB	589.00	10 / 200



V3021 8099 8080



8117 8097 8086A



8083 8098

● PACKING CHANGE

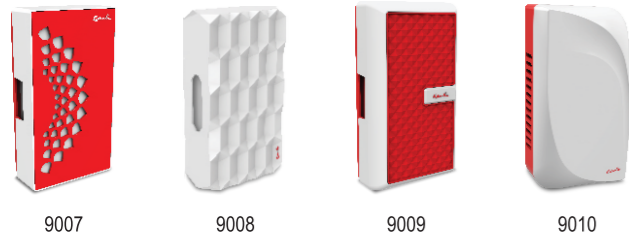

\* NEWLY INTRODUCED

CODE	ITEM	MRP(Rs.)	PKG OUTER / MASTER
<b>ZINE PLUS DING DONG BELLS</b>			
9001	Spark Ding Dong Bell stereophonic ding dong	217.00	05 / 100
9002	Aqua Ding Dong Bell stereophonic ding dong	217.00	05 / 100
V 3031	Pulse Ding Dong Bell stereophonic ding dong	217.00	05 / 100
V 3032	Plug Ding Dong Bell stereophonic ding dong	217.00	05 / 100
9003	Wave Ding Dong Bell stereophonic ding dong	274.00	05 / 100
9004	Oval Ding Dong Bell stereophonic ding dong	217.00	05 / 100
9005	Bella Ding Dong Bell stereophonic ding dong	217.00	05 / 100
9006	Fiona Ding Dong Bell stereophonic ding dong	251.00	05 / 100
9007	Elvis Ding Dong Bell stereophonic ding dong	251.00	05 / 100
9008*	Hexa Ding Dong Bell (New) stereophonic ding dong	217.00	05 / 100
9009*	Etos Ding Dong Bell (New) stereophonic ding dong	251.00	05 / 100
9010*	Pearl Ding Dong Bell (New) stereophonic ding dong	217.00	05 / 100

CODE	ITEM	MRP(Rs.)	PKG OUTER / MASTER
<b>ZINE PLUS MUSICAL DOOR BELL</b>			
9011	Apple Musical Bell 16 Melodies tune	446.00	05 / 100
9014	Parrot Musical Bell	281.00	05 / 100
9015	Ringo Musical Bell 12 melodies tune	457.00	05 / 80
9016	Itune Musical Bell 12 melodies tune	413.00	10 / 240
V 3041	Musical Bell ( Om Mantras ) with flashing light	518.00	05 / 100
V 3041A*	Musical Bell ( Azaan ) (New) with flashing light	518.00	05 / 100
V 3041B*	Musical Bell ( Satnam Waheguru ) (New) with flashing light	518.00	05 / 100
V 3041C*	Musical Bell ( Church ) (New) with flashing light	518.00	05 / 100
V 3041D*	Musical Bell ( Shri Krishna ) (New) with flashing light	518.00	05 / 100
V 3042	Flora Musical Bell with 16 melodies & flashing light	538.00	05 / 80

CODE	ITEM	MRP(Rs.)	PKG OUTER / MASTER
<b>ZINE PLUS PLUG IN WIRELESS DOOR BELL</b> <span style="background-color: red; color: white; padding: 2px;">NEW</span>			
9017	Vox Plug in Wireless Door Bell with kinetic remote, 32 selectable tunes, 2 in 1 indicator & LED night lamp and volume control	1750.00	05 / 40
9018	Luna Plug in Wireless Door Bell with kinetic remote, 32 selectable tunes, 2 in 1 indicator & LED night lamp and volume control	1750.00	05 / 40

CODE	ITEM	MRP(Rs.)	PKG OUTER / MASTER
<b>ZINE PLUS SHINE NIGHT LAMP</b>			
8131*	SHRI PARASWANATH	231.00	10 / 300
8132*	LORD GANESHA	231.00	10 / 300
8133*	MAHALAKSHMI	231.00	10 / 300
8134*	TIRUPATI BALAJI	231.00	10 / 300
8135*	SHRI KRISHNA	231.00	10 / 300
8136*	SHIVJI	231.00	10 / 300
8137*	AMBE MATA	231.00	10 / 300
8138*	SHRI HANUMAN	231.00	10 / 300
8139*	GURU NANAK	231.00	10 / 300
8140*	AZAAN	231.00	10 / 300
8141*	JESUS CHRIST	231.00	10 / 300
8142*	SAI BABA	231.00	10 / 300

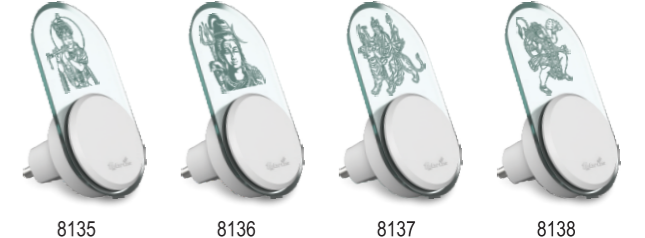

CODE	ITEM	MRP(Rs.)	PKG OUTER / MASTER
<b>ZINE PLUS GLOW NIGHT LAMP</b>			
8146*	GLOW Night Lamp (Lord Ganesha Mantra)	231.00	10 / 300



CODE	ITEM	MRP(Rs.)	PKG OUTER / MASTER
<b>ZINE PLUS 6AMP / 16AMP FLEX BOX</b>			
8091	Comex 2 Pin Flex Box (5 Mtrs.) with indicator & international socket Red Blue Orange Yellow	357.00	05 / 60
8092	Comex 2 Pin Flex Box (10 Mtrs.) with indicator & international socket Red Blue Orange Yellow	464.00	05 / 60
8093	Comex 3 Pin Flex Box (5 Mtrs.) with indicator & international socket Red Blue Orange Yellow	464.00	05 / 60
8094	Crystal 2 Pin Flex Box (5 Mtrs.) with indicator & international socket	412.00	05 / 60
8095*	Prizma 16A 3 Pin Flex Box (3.5 Mtrs.) with indicator & international socket	1065.00	01 / 30
V 3061	Fusion 2 Pin Flex Box (5 Mtrs.) with indicator & international socket	383.00	05 / 60



● PACKING CHANGE

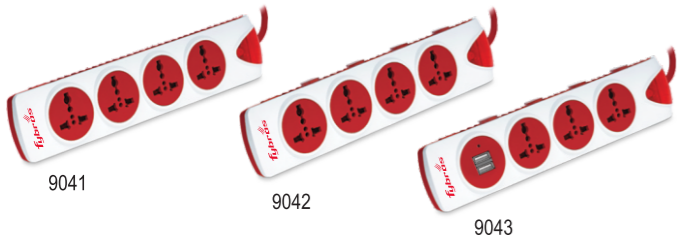
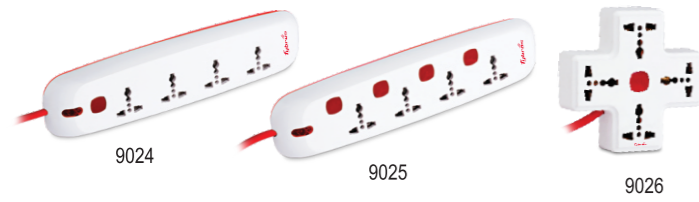
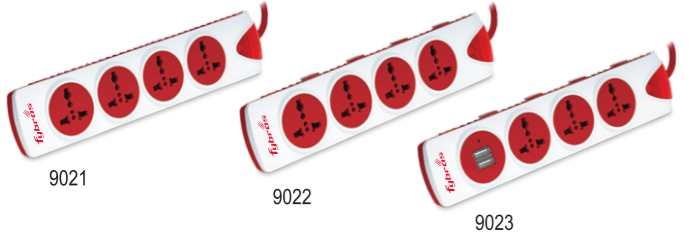
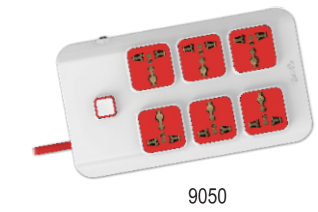
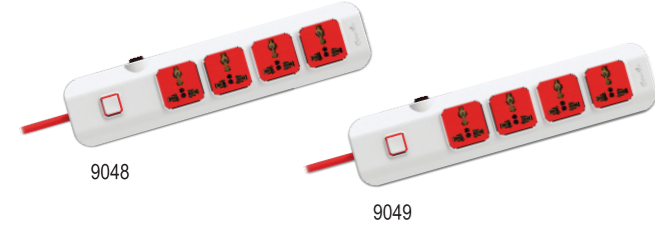

CODE	ITEM	MRP(Rs.)	PKG OUTER / MASTER
------	------	----------	--------------------

**ZINE PLUS EXTENSION CORDS**

9046	Stella 2 Pin Extension Cords with indicator & international socket (2.5 Mtrs.)	440.00	05 / 100
9047	Stella 3 Pin Extension Cords with indicator & international socket (1.5 Mtrs.)	474.00	05 / 100

**ZINE PLUS SPIKE GUARDS**

9048	Curve 4 x 1 Spike Guard master switch, indicator, surge protector & international socket (2 Mtrs.)	1025.00	05 / 50
9049	Curve 4 x 1 Spike Guard master switch, indicator, surge protector & international socket (5 Mtrs.)	1246.00	05 / 50
9050	Curve 6 x 1 Spike Guard master switch, indicator, surge protector & international socket (2 Mtrs.)	1246.00	05 / 40

**ZINE PLUS POWER STRIP (2Mtrs.)**

9021	Qubic 4 x 1 Power Strip master switch, indicator & intl. socket	702.00	05 / 50
9022	Qubic 4 x 4 Power Strip individual switch, indicator & intl. socket	793.00	05 / 50
9023	Qubic 4 x 4 Power Strip with USB individual switch, usb port, indicator & intl. socket	1254.00	05 / 50
9024	Titan 4 x 1 Power Strip master switch, indicator & intl. socket	686.00	05 / 50
9025	Titan 4 x 4 Power Strip individual switch, indicator & intl. socket	781.00	05 / 50
9026	F-Plus 4 x 1 Power Strip master switch & intl. socket	600.00	05 / 60

- Red
- Blue
- Orange
- Yellow

**ZINE PLUS POWER STRIP (5Mtrs.)**

9041	Qubic 4 x 1 Power Strip master switch, indicator & intl. socket	752.00	05 / 50
9042	Qubic 4 x 4 Power Strip individual switch, indicator & intl. socket	844.00	05 / 50
9043	Qubic 4 x 4 Power Strip with USB individual switch, usb port, indicator & intl. socket	1301.00	05 / 50
9044	Titan 4 x 1 Power Strip master switch, indicator & intl. socket	734.00	05 / 50
9045	Titan 4 x 4 Power Strip individual switch, indicator & intl. socket	832.00	05 / 50

CODE	ITEM	MRP(Rs.)	PKG OUTER / MASTER
------	------	----------	--------------------

**ZINE PLUS ANGLE / BATTEN HOLDER (UNBREAKABLE)**

9059	Gio Angle Holder	66.00	20 / 400
9060	Gio Batten Holder	66.00	20 / 400
9058	Gio Jumbo Batten Holder	77.00	20 / 400
9066	4G Angle Holder	79.00	20 / 400
9067	4G Batten Holder	79.00	20 / 400
9057	Brio Batten Holder	57.00	20 / 400
9056	Brio Jumbo Batten Holder	69.00	20 / 400
9069	Angle Holder	49.00	20 / 400
9070	Batten Holder	49.00	20 / 400
9073	Sleek Angle Holder	51.00	30 / 600
9074	Sleek Batten Holder	51.00	30 / 600
9071	Circular Pilot Ceiling Rose	51.00	30 / 600
9072*	Jumbo Ceiling Rose	60.00	20 / 600
9075	Unique Ceiling Rose	40.00	40 / 800



**ZINE PLUS SQUARE ANGLE / BATTEN HOLDER (UNBREAKABLE)**

9081*	Square Angle Holder	97.00	15 / 300
9082*	Square Batten Holder	97.00	15 / 300
9083	Square Pilot Ceiling Rose	76.00	20 / 600
9084*	Gio Square Angle Holder	91.00	15 / 300
9085*	Gio Square Batten Holder	91.00	15 / 300
9086	5X5 Square Angle Holder	91.00	20 / 400
9087	5X5 Square Batten Holder	91.00	20 / 400
9095	5X5 Square Blank Plate	76.00	30 / 600



\* PACKING CHANGE

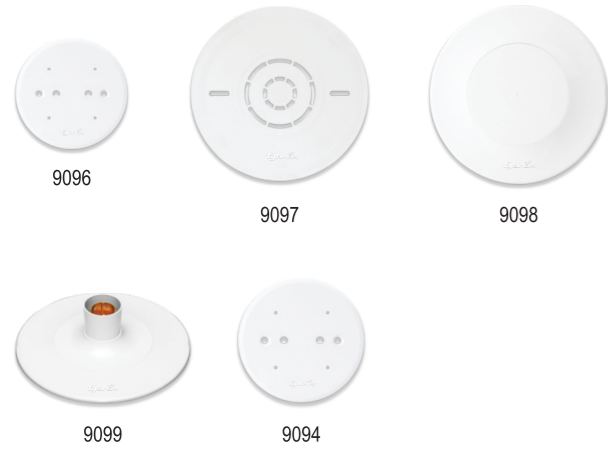
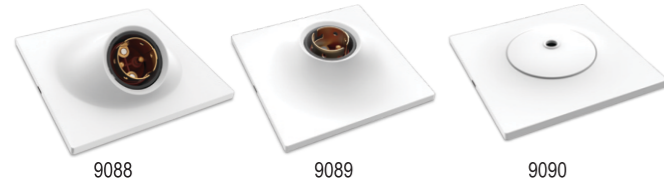

CODE	ITEM	MRP(Rs.)	PKG OUTER / MASTER
<b>ZINE PLUS SQUARE ANGLE / BATTEN HOLDER (UNBREAKABLE)</b>			
9088*	Twist Angle Holder	91.00	15 / 300
9089*	Twist Batten Holder	91.00	15 / 300
9090	Twist Pilot Ceiling Rose	85.00	30 / 600
9053	Zuri Angle Holder	91.00	15 / 300
9054	Zuri Batten Holder	91.00	15 / 300

CODE	ITEM	MRP(Rs.)	PKG OUTER / MASTER
<b>ZINE PLUS WIRE LINK 5 Mtrs. / STARTER</b>			
9091	Wire Link 5 Mtrs. with 2 Pin Plug & Pendant Holder	190.00	10 / 160
9031*	Nano 20/40W. Starter	16.00	100 / 2000

CODE	ITEM	MRP(Rs.)	PKG OUTER / MASTER
<b>ZINE PLUS ROUND JUNCTION PLATES</b>			
9096*	Round Junction Plate size 3.3 inch	14.00	100 / 2000
9097*	Fan Junction Plate size 6.5 inch	46.00	25 / 600
9098	Round Fan Junction Plate size 6.15 inch	69.00	25 / 400
9099	Round Batten Holder size 6.15 inch	102.00	10 / 200
9094*	Round Junction Plate (New) size 4. inch	17.00	100 / 2000

CODE	ITEM	MRP(Rs.)	PKG OUTER / MASTER
<b>VIVARIA CUBE WOOD PLATES</b>			
V 4001	4.5 x 4.5 Plate	66.00	10 / 480
V 4002	4.5 x 6.5 Plate	89.00	10 / 480
V 4003	4.5 x 8.5 Plate	122.00	10 / 240
V 4004	4.5 x 10.5 Plate	171.00	10 / 240
V 4005	4.5 x 12.5 Plate	181.00	10 / 240
V 4006	4.5 x 15.5 Plate	214.00	10 / 240
V 4009	6.5 x 8.5 Plate	210.00	10 / 180
V 4010	6.5 x 10.5 Plate	250.00	10 / 180
V 4011	6.5 x 12.5 Plate	280.00	10 / 180
V 4014	7.5 x 10.5 Plate	298.00	10 / 120
V 4017	8.5 x 10.5 Plate	315.00	10 / 120
V 4018	8.5 x 12.5 Plate	332.00	10 / 120
V 4021	10.5 x 12.5 Plate suitable for wooden boxes	341.00	10 / 120





ZUNIX  
POLYCARBONATE SERIES

# ZUNIX

POLYCARBONATE SERIES

OUR CUTTING-EDGE ELECTRICAL ACCESSORIES RANGE, DESIGNED TO ENHANCE YOUR DAILY LIFE. DISCOVER A WIDE SELECTION OF INNOVATIVE AND RELIABLE PRODUCTS THAT SEAMLESSLY INTEGRATE INTO YOUR HOME OR OFFICE.



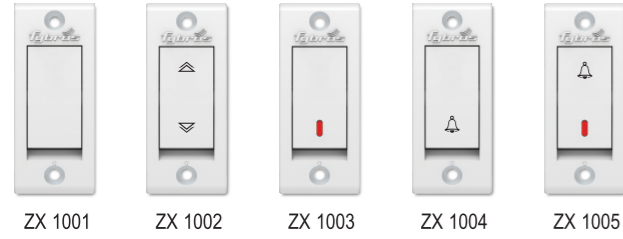

CODE	ITEM	MRP(Rs.)	WHITE / BROWN	PKG OUTER / MASTER
<b>ZUNIX 6 AMP. NOVA SWITCHES</b>				
ZX 1001	One Way Switch	37.00		20 / 1200
ZX 1002	Two Way Switch	46.00		20 / 1200
ZX 1003	One Way Switch With Ind.	47.00		20 / 1200
ZX 1004	Bell Push Switch	47.00		20 / 1200
ZX 1005	Bell Push Switch With Ind.	62.00		20 / 1200

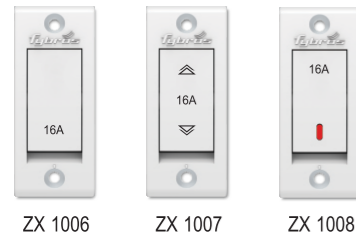

CODE	ITEM	MRP(Rs.)	WHITE / BROWN	PKG OUTER / MASTER
<b>ZUNIX 16 AMP. NOVA SWITCHES</b>				
ZX 1006	One Way Switch	65.00		20 / 1200
ZX 1007	Two Way Switch	76.00		20 / 1200
ZX 1008	One Way Switch With Ind.	76.00		20 / 1200



CODE	ITEM	MRP(Rs.)	WHITE / BROWN	PKG OUTER / MASTER
<b>ZUNIX 6 AMP. NOVA GAMA SWITCH</b>				
ZX 1009	Bell Push Switch With Ind.	71.00		10 / 600



CODE	ITEM	MRP(Rs.)	WHITE / BROWN	PKG OUTER / MASTER
<b>ZUNIX 32 AMP. NOVA D.P. SWITCH</b>				
ZX 1010	D.P. Switch With Ind.	202.00		10 / 600

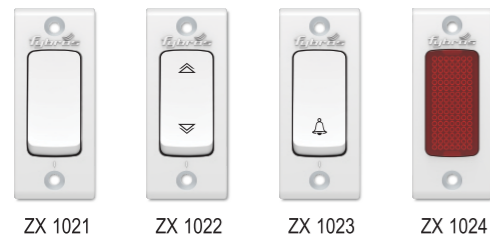

CODE	ITEM	MRP(Rs.)	WHITE / BROWN	PKG OUTER / MASTER
<b>ZUNIX 6 AMP. OPUS SWITCHES</b>				
ZX 1021	One Way Switch	30.00		20 / 1200
ZX 1022	Two Way Switch	37.00		20 / 1200
ZX 1023	Bell Push Switch	37.00		20 / 1200
ZX 1024	Indicator	37.00		20 / 1200

CODE	ITEM	MRP(Rs.)	WHITE / BROWN	PKG OUTER / MASTER
<b>ZUNIX 6 AMP. SOCKET</b>				
ZX 1032	3 Pin Socket	43.00		10 / 600
ZX 1033*	2 IN 1 Socket (New)	43.00		10 / 600



CODE	ITEM	MRP(Rs.)	WHITE / BROWN	PKG OUTER / MASTER
<b>ZUNIX TV ANTENA / TEL. JACK / KITKAT FUSE</b>				
ZX 1036	Mini Tv Socket	50.00		20 / 1200
ZX 1037	Mini 2 Line Tel. Jack With Enclosure	83.00		20 / 1200
ZX 1038	10Amp. Kitkat Fuse	51.00		10 / 600



CODE	ITEM	MRP(Rs.)	WHITE / BROWN	PKG OUTER / MASTER
<b>ZUNIX DIMMER &amp; REGULATOR</b>				
ZX 1041	RIO Mini Dimmer	212.00		20 / 400
ZX 1042	RIO Medium Dimmer	219.00		10 / 300
ZX 1043	RIO 4 Step Regulator	291.00		20 / 400
ZX 1044	RIO 5 Step Regulator	334.00		10 / 300



CODE	ITEM	MRP(Rs.)	WHITE / BROWN	PKG OUTER / MASTER
<b>ZUNIX 6 AMP. S.S. COMBINED WITH JUNCTION BOX</b>				
ZX 1051	6Amp. S. S. Combined with Ind.	97.00		05 / 200
ZX 1052	6Amp. S. S. Combined with Ind. & J. Box	110.00		05 / 200



CODE	ITEM	MRP(Rs.)	WHITE / BROWN	PKG OUTER / MASTER
<b>ZUNIX 16 AMP. SWITCHES &amp; SOCKET / 32 AMP. D.P. Switch</b>				
ZX 1056	16Amp. One Way Switch (Dolly)	120.00		10 / 200
ZX 1057	16Amp. Two Way Switch (Dolly)	147.00		10 / 200
ZX 1058	6 & 16Amp. Universal Socket Without Shutter (Dolly)	120.00		10 / 200
ZX 1060	32Amp. D.P. Switch With Ind.	213.00		10 / 200



\* NEWLY INTRODUCED



ZX 1061

ZX 1062



ZX 1063

ZX 1064



ZX 1066

ZX 1067



ZX 1068

ZX 1069



ZX 1081

ZX 1082



ZX 1083

ZX 1084

NEWLY INTRODUCED

CODE	ITEM	MRP(Rs.)	WHITE / BROWN	PKG OUTER / MASTER
------	------	----------	---------------	--------------------

**ZUNIX 16 AMP. 3 IN 1 WITH JUNCTION BOX**

ZX 1061	3 In 1 Uni. S. S. Combined (Dolly) - Ind.	206.00		05 / 100
ZX 1062	3 In 1 Uni. S. S. Combined With Junction Box (Dolly) - Ind.	224.00		05 / 100
ZX 1063	3 In 1 Uni. S. S. Combined With Safety Shutter (Dolly)	206.00		05 / 100
ZX 1064	3 In 1 Uni. S. S. Combined With Safety Shutter & Junction Box (Dolly)	224.00		05 / 100

**ZUNIX 16 AMP. 5 IN 1 WITH JUNCTION BOX**

ZX 1066	5 In 1 Uni. S. S. Combined (Dolly) - Ind., Kit Kat Fuse	282.00		05 / 100
ZX 1067	5 In 1 Uni. S. S. Combined With Junction Box (Dolly) - Ind., Kit Kat Fuse	320.00		05 / 100
ZX 1068	5 In 1 Uni. S. S. Combined (Dolly) - Ind., Kit Kat Fuse & Safety Shutter	282.00		05 / 100
ZX 1069	5 In 1 Uni. S. S. Combined With Junction Box (Dolly) - Ind., Kit Kat Fuse & Safety Shutter	320.00		05 / 100

**ZUNIX 16 AMP. SQUARE 5 IN 1 WITH JUNCTION BOX NEW**

ZX 1081	Square 5 In 1 Uni. S. S. Combined (Dolly) - Ind., Kit Kat Fuse	282.00		05 / 100
ZX 1082	Square 5 In 1 Uni. S. S. Combined With Junction Box (Dolly)- Ind., Kit Kat Fuse	320.00		05 / 100
ZX 1083	Square 5 In 1 Uni. S. S. Combined (Dolly) - Ind., Kit Kat Fuse & Safety Shutter	282.00		05 / 100
ZX 1084	Square 5 In 1 Uni. S. S. Combined With Junction Box (Dolly) - Ind., Kit Kat Fuse & Safety Shutter	320.00		05 / 100

CODE	ITEM	MRP(Rs.)	WHITE / BROWN	PKG OUTER / MASTER
------	------	----------	---------------	--------------------

**ZUNIX 6A. 6 IN 1 & 16A. 8 IN 1 WITH JUNCTION BOX**

ZX 1071	6 In 1 S. S. Combined With Junction Box (Dolly) - Ind.	300.00		05 / 100
ZX 1073	8 In 1 S. S. Combined With Junction Box (Dolly) - Ind.	456.00		05 / 60



ZX 1071

ZX 1073

**ZUNIX HOLDER (UNBREAKABLE)**

ZX 1076	Pendent Holder	33.00		30 / 600
ZX 1077	Adaptor	32.00		30 / 1200



ZX 1076

ZX 1077

